



High-end Power Semiconductor Manufacturer

KP3200A 7600V-8000V Phase Control Thyristor

- High power cycling capability
- Low on-state and switching losses
- Designed for traction and industrial applications



Mean on-state current	I_{TAV}		3200 A		
Repetitive peak off-state voltage	V_{DRM}		7600 - 8000 V		
Repetitive peak reverse voltage	V_{RRM}				
Turn-off time	t_q		900 μ s		
V_{DRM}, V_{RRM}, V	7600	7700	7800	7900	8000
Voltage code	76	77	78	79	80
$T_j, ^\circ C$	-40 - 110				

MAXIMUM ALLOWABLE RATINGS

Symbols and parameters		Units	Values	Test conditions	
ON-STATE					
I_{TAV}	Mean on-state current	A	3200	$T_c=70\text{ }^\circ C$; 180° half-sine wave;	
I_{TRMS}	RMS on-state current	A	5024	$T_c=70\text{ }^\circ C$	
I_{TSM}	Surge on-state current	kA	65.0	$T_j=T_{j\text{ max}}$	180° half-sine wave; ($t_p=10\text{ ms}$); $V_R=0\text{ V}$;
I^2t	Safety factor	$A^2s \cdot 10^4$	2110		180° sine wave; ($t_p=10\text{ ms}$);
BLOCKING					
V_{DRM}, V_{RRM}	Repetitive peak off-state and Repetitive peak reverse voltages	V	7600-8000	$T_{j\text{ min}} < T_j < T_{j\text{ max}}$; 180° half-sine wave; 50 Hz; Gate open	
V_{DSM}, V_{RSM}	Non-repetitive peak off-state and Non-repetitive peak reverse voltages	V	8100-8500	$T_{vj} = 25, 110\text{ }^\circ C$; $I_{DRM}, I_{RRM} \leq 800\text{ mA}$; $V_{DM} = V_{DRM}; V_{RM} = V_{RRM}$; $t_p = 10\text{ ms}$; Gate open	

TRIGGERING				
I_{FGM}	Peak forward gate current	A	4	
V_{RGM}	Peak reverse gate voltage	V	5	
P_G	Gate power dissipation	W	20	
SWITCHING				
$(di_T/dt)_{crit}$	Critical rate of rise of on-state current non-repetitive	A/ μ s	100	$T_{vj} = 110^\circ\text{C}; V_{DM} = 0.67 V_{DRM}; f = 50 \text{ Hz}; I_{TM} = 3000 \text{ A}; I_{FG} = 2 \text{ A}; t_r = 0.5 \mu\text{s}$
THERMAL				
T_{stg}	Storage temperature	$^\circ\text{C}$	-40-140	
T_j	Operating junction temperature	$^\circ\text{C}$	-40-110	
MECHANICAL				
F	Mounting force	kN	120.0	

CHARACTERISTICS

Symbols and parameters		Units	Values	Conditions
ON-STATE				
V_{TM}	Peak on-state voltage, max	V	2.05	$T_j = 110^\circ\text{C}; I_{TM} = 3000 \text{ A}$
$V_{T(TO)}$	On-state threshold voltage, max	V	1.15	$T_j = T_{j \max}$
r_T	On-state slope resistance, max	m Ω	0.300	
I_L	Latching current, max	mA	1000	$T_j = 25^\circ\text{C}$
I_H	Holding current, max	mA	200	$T_j = 25^\circ\text{C}$
BLOCKING				
I_{DRM}, I_{RRM}	Repetitive peak off-state and Repetitive peak reverse currents, max	mA	800	$T_j = 25^\circ\text{C}, 110^\circ\text{C}; V_{DRM}/V_{RRM};$ Gate open
$(dv_D/dt)_{crit}$	Critical rate of rise of off-state voltage ¹⁾ , min	V/ μ s	2000	$T_j = T_{j \max}; V_D = 0.67 \cdot V_{DRM};$ Gate open
TRIGGERING				
V_{GT}	Gate trigger direct voltage, max	V	3.00	$T_j = 25^\circ\text{C}$
I_{GT}	Gate trigger direct current, max	mA	300	$T_j = 25^\circ\text{C}$
V_{GD}	Gate non-trigger direct voltage, min	V	0.30	$T_j = T_{j \max}; V_D = 0.4 \cdot V_{DRM};$
SWITCHING				
t_q	Turn-off time ²⁾ , max	μ s	900	$T_{vj} = 110^\circ\text{C}; V_{DM} = 0.67 V_{DRM}; I_T = 2000 \text{ A}; dv/dt = 20 \text{ V}/\mu\text{s}; V_R = 200 \text{ V}; -di/dt = 1.5 \text{ A}/\mu\text{s}$
Q_{rr}	Total recovered charge, max	μ C	5500	$T_{vj} = 110^\circ\text{C}; -di/dt = 1.5 \text{ A}/\mu\text{s}; I_T = 2000 \text{ A}; V_R = 200 \text{ V}$
I_{rrM}	Peak reverse recovery current, max	mA	800	$T_{vj} = 25^\circ\text{C}, 110^\circ\text{C}; V_{DRM}/V_{RRM}$ Gate open

THERMAL				
R_{thjc}	Thermal resistance, junction to case, max	$^{\circ}\text{C}/\text{W}$	0.0040	Direct current
R_{thck}	Thermal resistance, case to heatsink, max	$^{\circ}\text{C}/\text{W}$	0.0008	Direct current
MECHANICAL				
w	Weight, typ	g	3600	

Beijing Xinchuang Chunshu Rectifier Co., Ltd

OVERALL DIMENSIONS

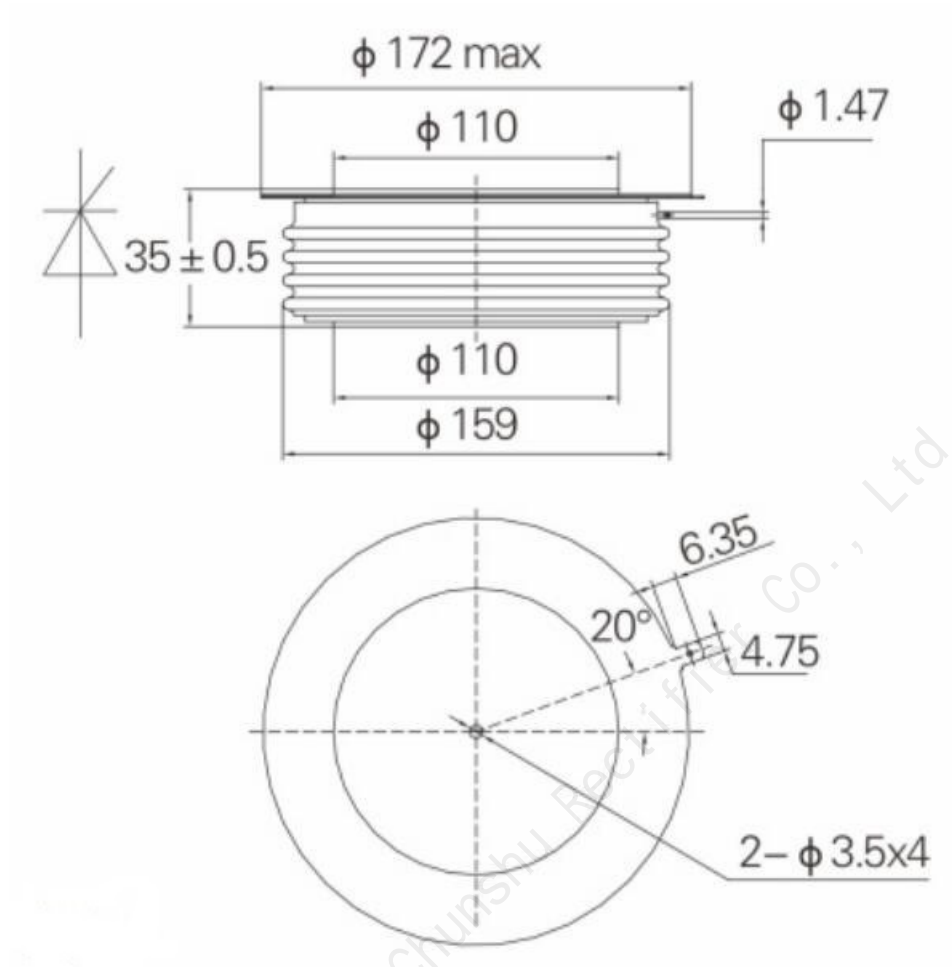

KT120DT

All dimensions in millimeters



图1. 通态伏安特性曲线



图2. 瞬态热阻抗曲线

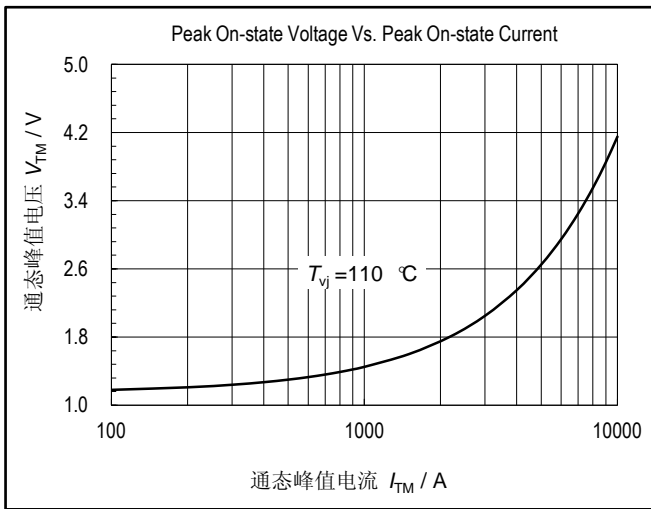

图3. 最大功耗与通态平均电流的关系曲线

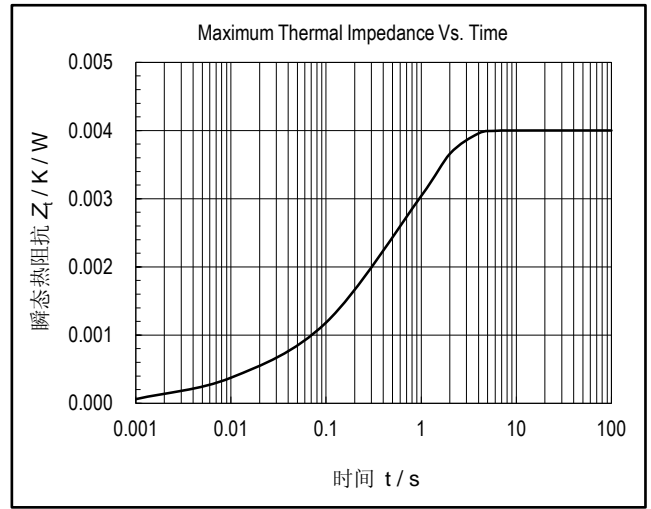

图4. 管壳温度与通态平均电流的关系曲线

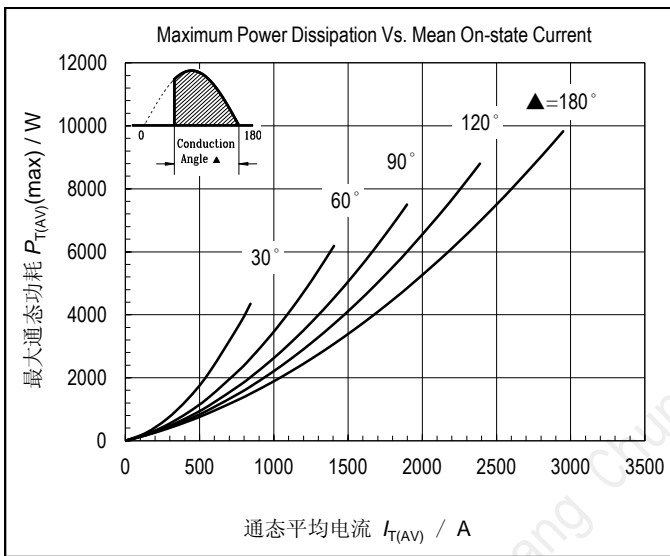

图5. 最大通态功耗与通态平均电流的关系曲线

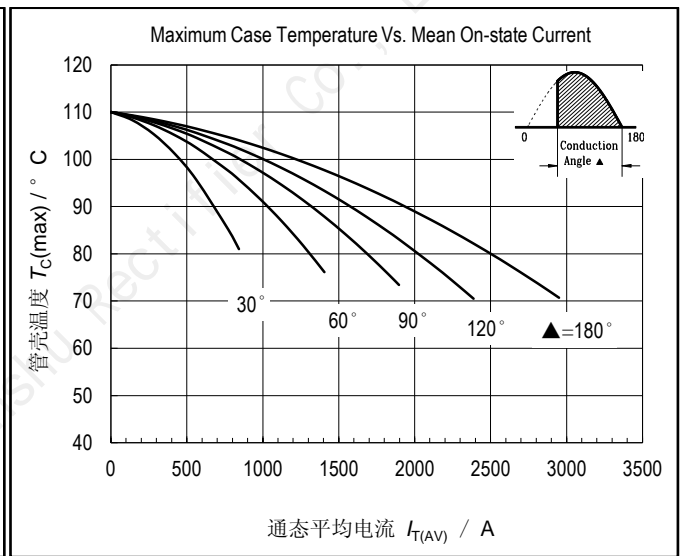

图6. 管壳温度与通态平均电流的关系曲线

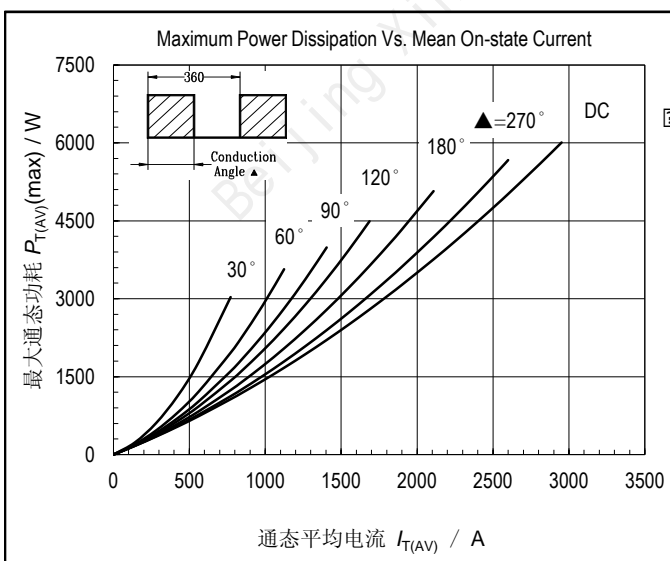

图7. 通态浪涌电流与周波数的关系曲线

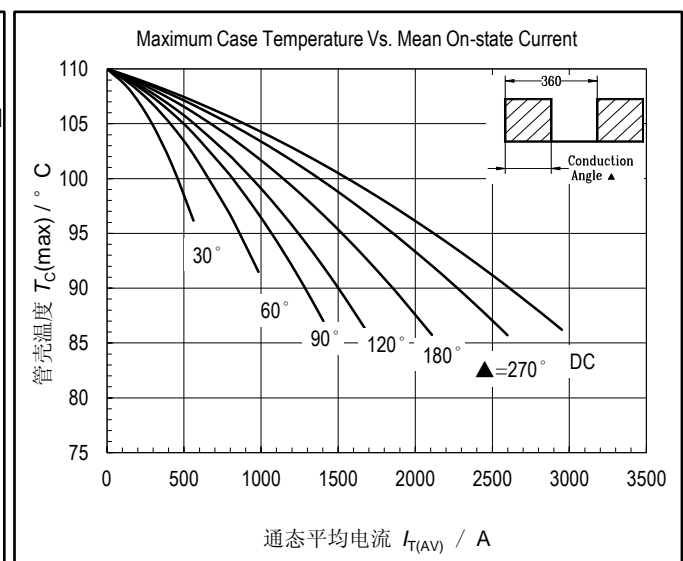

图8. I^2t 特性曲线

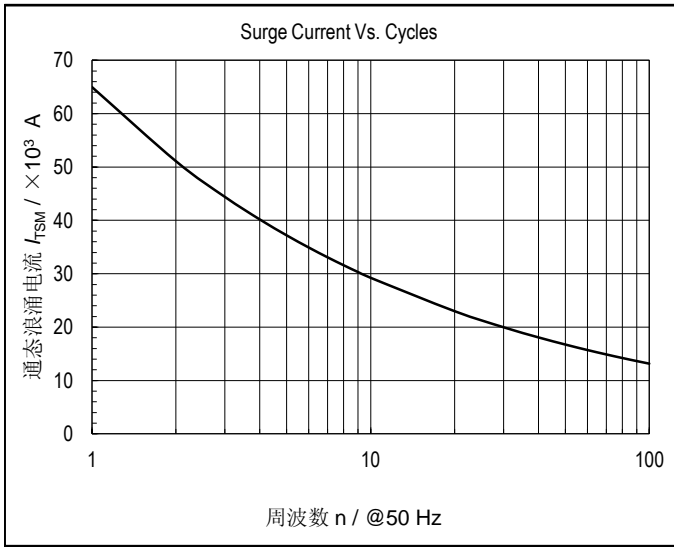

图9. 门极触发特性曲线

A为可靠触发区，
B为不可靠触发区。
C为建议采用的门极负载线。

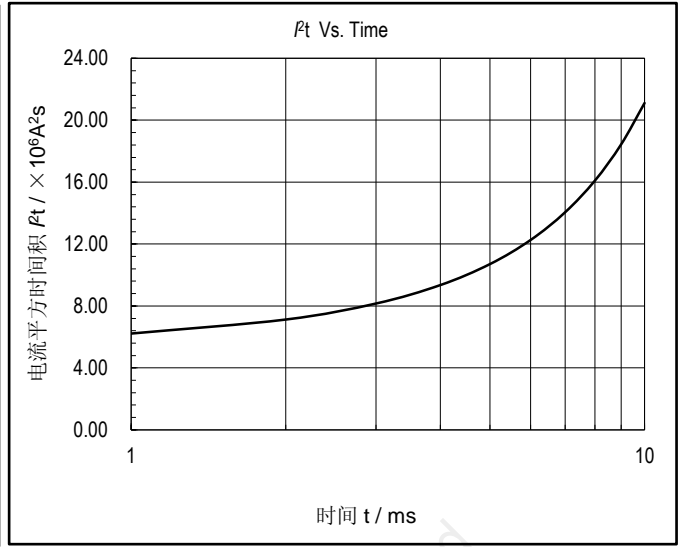

图10. 不同结温下的门极触发区

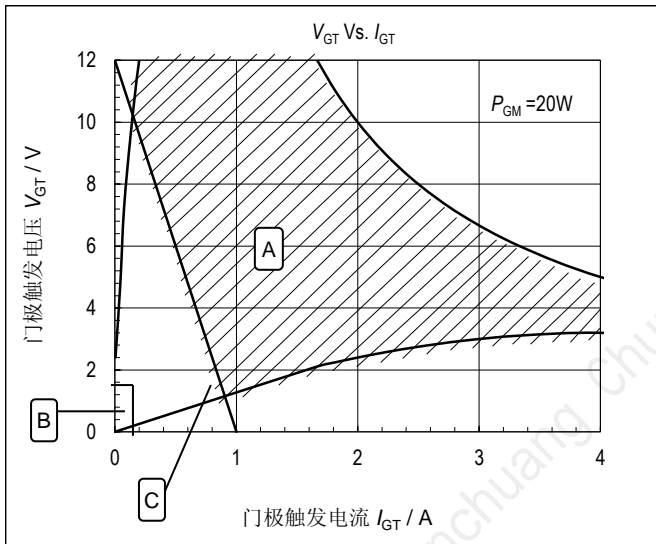
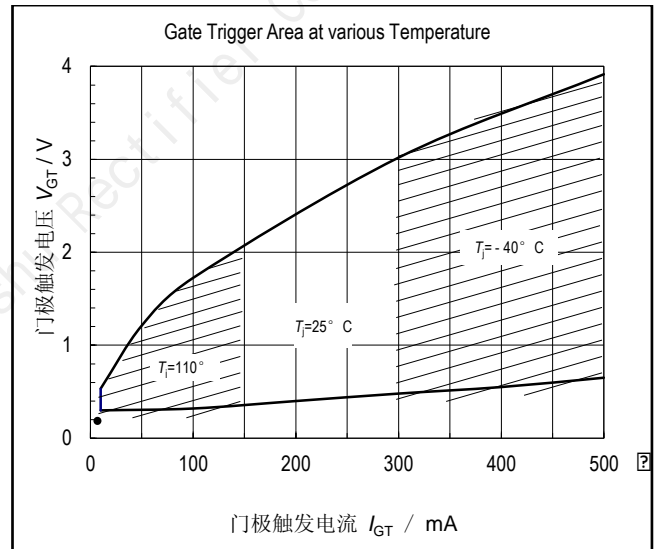
A is Recommended Triggering Area.
B is Unreliable Triggering Area.
C is Recommended Gate Load Line.