



High-end Power Semiconductor Manufacturer

KP3600A 3000V-3600V Phase Control Thyristor

- High power cycling capability
- Low on-state and switching losses
- Designed for traction and industrial applications



Mean on-state current	I_{TAV}	3600 A		
Repetitive peak off-state voltage	V_{DRM}	3000 – 3600 V		
Repetitive peak reverse voltage	V_{RRM}			
Turn-off time	t_q	630 μ s		
V_{DRM}, V_{RRM}, V	3000	3200	3400	3600
Voltage code	30	32	34	36
$T_j, ^\circ\text{C}$	– 60 – 125			

MAXIMUM ALLOWABLE RATINGS

Symbols and parameters		Units	Values	Test conditions
ON-STATE				
I_{TAV}	Mean on-state current	A	3600	$T_c = 85^\circ\text{C}$, Double side cooled 180° half-sine wave; 50 Hz
I_{TRMS}	RMS on-state current	A	5652	$T_c = 85^\circ\text{C}$, Double side cooled 180° half-sine wave; 50 Hz
I_{TSM}	Surge on-state current	kA	72.0 83.0	$T_j = T_{j\max}$ $T_j = 25^\circ\text{C}$ 180° half-sine wave; 50 Hz ($t_p = 10$ ms); single pulse; $V_D = V_R = 0$ V; Gate pulse: $I_G = 2$ A; $t_{GP} = 50$ μ s; $di_G/dt \geq 1$ A/ μ s
			76.0 87.0	$T_j = T_{j\max}$ $T_j = 25^\circ\text{C}$ 180° half-sine wave; 60 Hz ($t_p = 8.3$ ms); single pulse; $V_D = V_R = 0$ V; Gate pulse: $I_G = 2$ A; $t_{GP} = 50$ μ s; $di_G/dt \geq 1$ A/ μ s
I^2t	Safety factor	$A^2s \cdot 10^3$	25920 34445	$T_j = T_{j\max}$ $T_j = 25^\circ\text{C}$ 180° half-sine wave; 50 Hz ($t_p = 10$ ms); single pulse; $V_D = V_R = 0$ V; Gate pulse: $I_G = 2$ A; $t_{GP} = 50$ μ s; $di_G/dt \geq 1$ A/ μ s
			23970 31410	$T_j = T_{j\max}$ $T_j = 25^\circ\text{C}$ 180° half-sine wave; 60 Hz ($t_p = 8.3$ ms); single pulse; $V_D = V_R = 0$ V; Gate pulse: $I_G = 2$ A; $t_{GP} = 50$ μ s; $di_G/dt \geq 1$ A/ μ s
BLOCKING				
V_{DRM}, V_{RRM}	Repetitive peak off-state and Repetitive peak reverse voltages	V	3000–3600	$T_{j\min} < T_j < T_{j\max}$; 180° half-sine wave; 50 Hz; Gate open
V_{DSM}, V_{RSM}	Non-repetitive peak off-state and Non-repetitive peak reverse voltages	V	3100–3700	$T_{j\min} < T_j < T_{j\max}$; 180° half-sine wave; 50 Hz; single pulse; Gate open
V_D, V_R	Direct off-state and Direct reverse voltages	V	$0.75 \cdot V_{DRM}$ $0.75 \cdot V_{RRM}$	$T_j = T_{j\max}$; Gate open

TRIGGERING				
I_{FGM}	Peak forward gate current	A	12	$T_j = T_{j\max}$
V_{RGM}	Peak reverse gate voltage	V	5	
P_G	Gate power dissipation	W	5	$T_j = T_{j\max}$ for DC gate current
SWITCHING				
$(di_T/dt)_{crit}$	Critical rate of rise of on-state current non-repetitive (f=1 Hz)	A/ μ s	1000	$T_j = T_{j\max}; V_D = 0.67 \cdot V_{DRM}; I_{TM} = 2 I_{TAV};$ Gate pulse: $I_G = 2$ A; $t_{GP} = 50 \mu$ s; $di_G/dt \geq 1$ A/ μ s
THERMAL				
T_{stg}	Storage temperature	$^{\circ}$ C	-60 – 125	
T_j	Operating junction temperature	$^{\circ}$ C	-60 – 125	
MECHANICAL				
F	Mounting force	kN	70.0 – 90.0	
a	Acceleration	m/s ²	50 100	Device unclamped Device clamped

CHARACTERISTICS

Symbols and parameters		Units	Values	Conditions	
ON-STATE					
V_{TM}	Peak on-state voltage, max	V	1.80	$T_j = 25 \text{ }^{\circ}\text{C}; I_{TM} = 6300$ A	
$V_{T(TO)}$	On-state threshold voltage, max	V	0.95	$T_j = T_{j\max};$	
r_T	On-state slope resistance, max	m Ω	0.140	$0.5 \pi I_{TAV} < I_T < 1.5 \pi I_{TAV}$	
I_L	Latching current, max	mA	1500	$T_j = 25 \text{ }^{\circ}\text{C}; V_D = 12$ V; Gate pulse: $I_G = 2$ A; $t_{GP} = 50 \mu$ s; $di_G/dt \geq 1$ A/ μ s	
I_H	Holding current, max	mA	300	$T_j = 25 \text{ }^{\circ}\text{C};$ $V_D = 12$ V; Gate open	
BLOCKING					
I_{DRM}, I_{RRM}	Repetitive peak off-state and Repetitive peak reverse currents, max	mA	300	$T_j = T_{j\max};$ $V_D = V_{DRM}; V_R = V_{RRM}$	
$(dv_D/dt)_{crit}$	Critical rate of rise of off-state voltage ¹⁾ , min	V/ μ s	1000	$T_j = T_{j\max};$ $V_D = 0.67 \cdot V_{DRM};$ Gate open	
TRIGGERING					
V_{GT}	Gate trigger direct voltage, max	V	3.00 2.00	$T_j = 25 \text{ }^{\circ}\text{C}$ $T_j = T_{j\max}$	$V_D = 12$ V; $I_D = 3$ A; Direct gate current
I_{GT}	Gate trigger direct current, max	mA	300 200	$T_j = 25 \text{ }^{\circ}\text{C}$ $T_j = T_{j\max}$	
V_{GD}	Gate non-trigger direct voltage, min	V	0.35	$T_j = T_{j\max};$ $V_D = 0.67 \cdot V_{DRM};$	
I_{GD}	Gate non-trigger direct current, min	mA	15.00	Direct gate current	
SWITCHING					
t_{gd}	Delay time	μ s	3.00	$T_j = 25 \text{ }^{\circ}\text{C}; V_D = 0.4 \cdot V_{DRM}; I_{TM} = 2000$ A; Gate pulse: $I_G = 2$ A; $t_{GP} = 50 \mu$ s; $di_G/dt \geq 1$ A/ μ s	
t_q	Turn-off time ²⁾ , max	μ s	630	$dv_D/dt = 50$ V/ μ s; $T_j = T_{j\max}; I_{TM} = 2000$ A; $di_R/dt = -10$ A/ μ s; $V_R = 100$ V; $V_D = 0.67 V_{DRM};$	
Q_{rr}	Total recovered charge, max	μ C	7000	$T_j = T_{j\max}; I_{TM} = 2000$ A;	
t_{rr}	Reverse recovery time, typ	μ s	68	$di_R/dt = -5$ A/ μ s;	
I_{rrM}	Peak reverse recovery current, max	A	205	$V_R = 100$ V	

THERMAL					
R_{thjc}	Thermal resistance, junction to case, max	°C/W	0.0057	Direct current	Double side cooled
R_{thjc-A}			0.0125		Anode side cooled
R_{thjc-K}			0.0103		Cathode side cooled
R_{thck}	Thermal resistance, case to heatsink, max	°C/W	0.0010	Direct current	
MECHANICAL					
w	Weight, typ	g	2700		
D_s	Surface creepage distance	mm (inch)	62.09 (2.444)		
D_a	Air strike distance	mm (inch)	23.40 (0.921)		

Beijing Xinchuang Chunshu Rectifier Co., Ltd

OVERALL DIMENSIONS

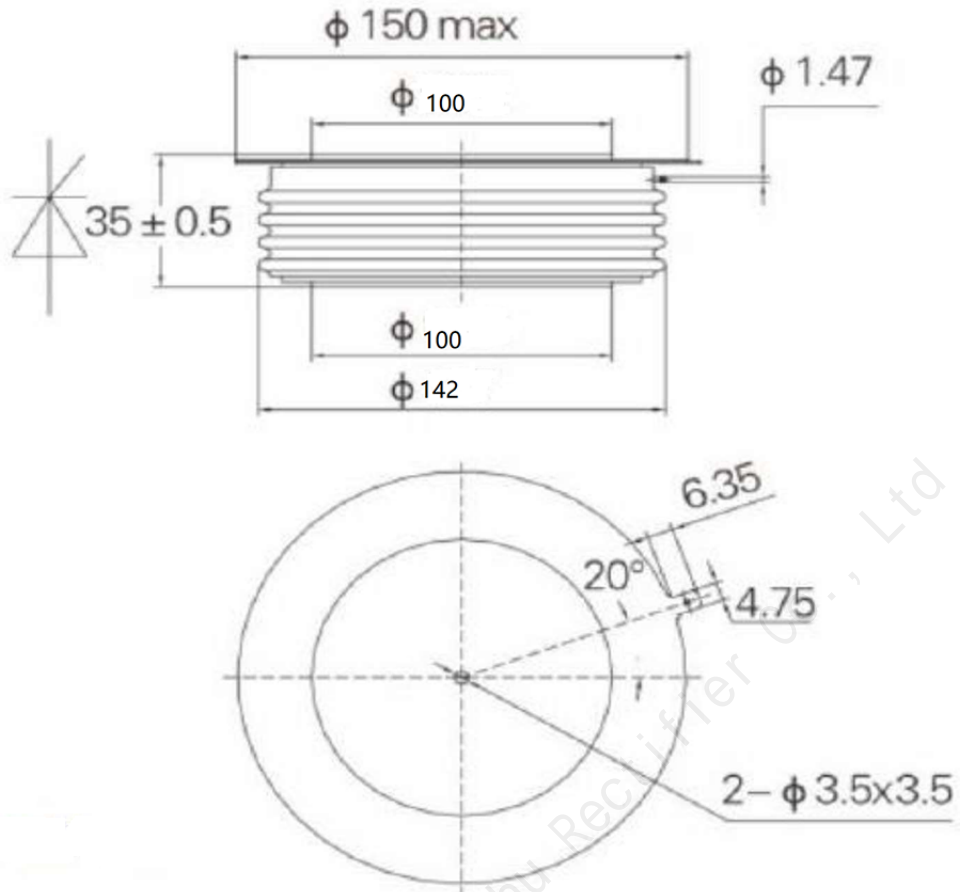

KT110DT

All dimensions in millimeters

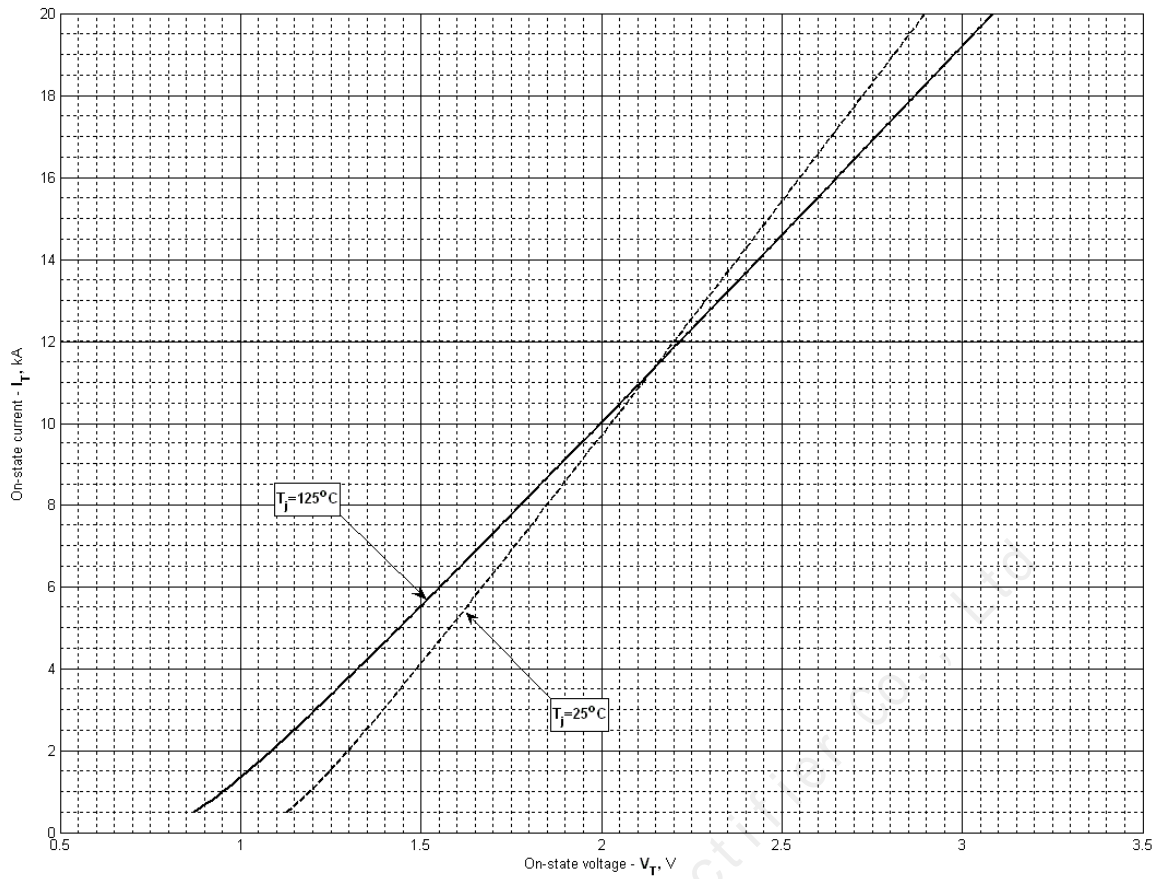

Fig 1 – On-state characteristics of Limit device

Analytical function for On-state characteristic:

$$V_T = A + B \cdot i_T + C \cdot \ln(i_T + 1) + D \cdot \sqrt{i_T}$$

	Coefficients for max curves	
	$T_j = 25^\circ\text{C}$	$T_j = T_{j\max}$
A	0.852713	1.112428
B	0.116208	0.092643
C	0.193655	0.144998
D	-0.152139	-0.113913

On-state characteristic model (see Fig. 1)

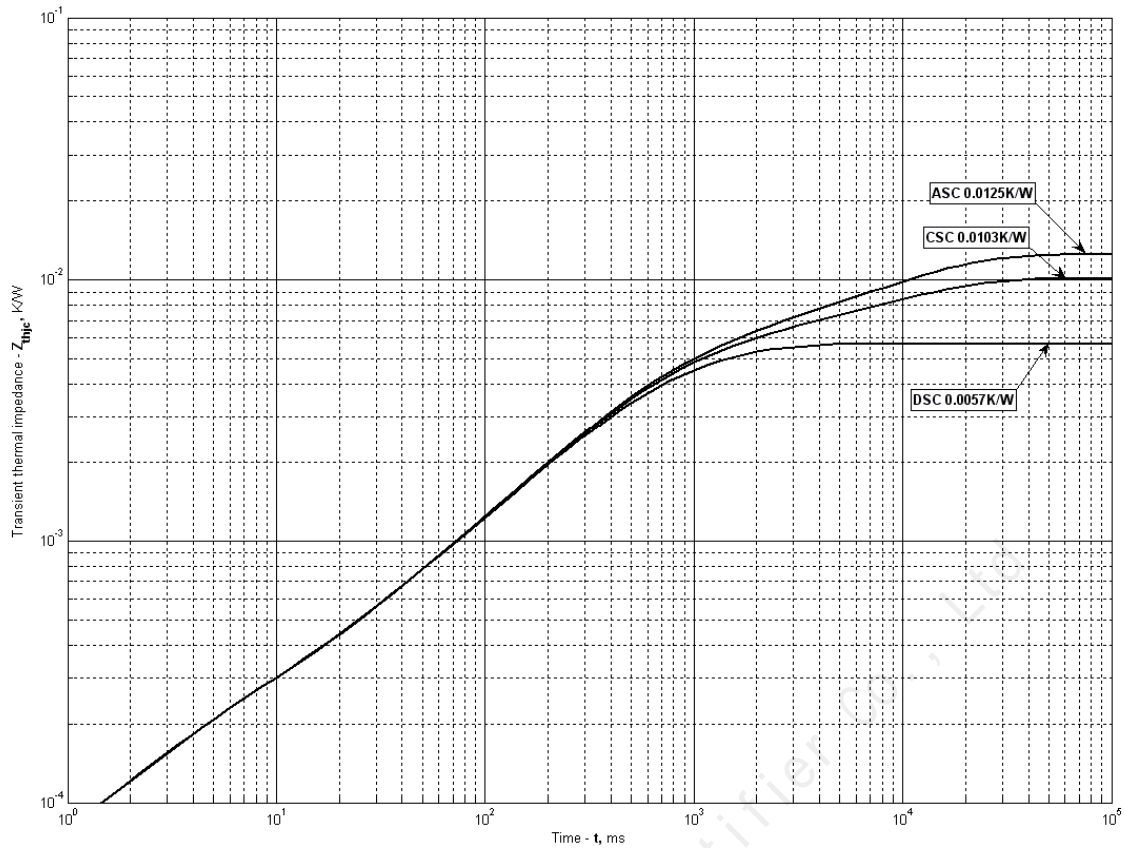

Fig 2 – Transient thermal impedance

Analytical function for Transient thermal impedance junction to case Z_{thjc} for DC:

$$Z_{thjc} = \sum_{i=1}^n R_i \left(1 - e^{-\frac{t}{\tau_i}} \right)$$

Where $i = 1$ to n , n is the number of terms in the series.

t = Duration of heating pulse in seconds.

Z_{thjc} = Thermal resistance at time t .

R_i = Amplitude of p_{th} term.

τ_i = Time constant of r_{th} term.

DC Double side cooled

i	1	2	3	4	5	6
$R_i, K/W$	0.002457	-0.003548	0.002909	0.0002069	3.51e-005	0.00364
$\tau_{ij} s$	1.062	0.005022	0.3787	0.0257	0.0003732	0.004916

DC Cathode side cooled

i	1	2	3	4	5	6
$R_i, K/W$	0.004458	0.002601	0.002763	0.0001806	0.0001224	3.094e-005
$\tau_{ij} s$	1.06	1.100	0.3794	0.0291	0.003057	0.0003374

DC Anode side cooled

i	1	2	3	4	5	6
$R_i, K/W$	0.006812	0.002637	0.002729	0.0001806	0.000122	3.069e-005
$\tau_{ij} s$	1.06	1.131	0.3835	0.02886	0.003033	0.0003349

Transient thermal impedance junction to case Z_{thjc} model (see Fig. 2)

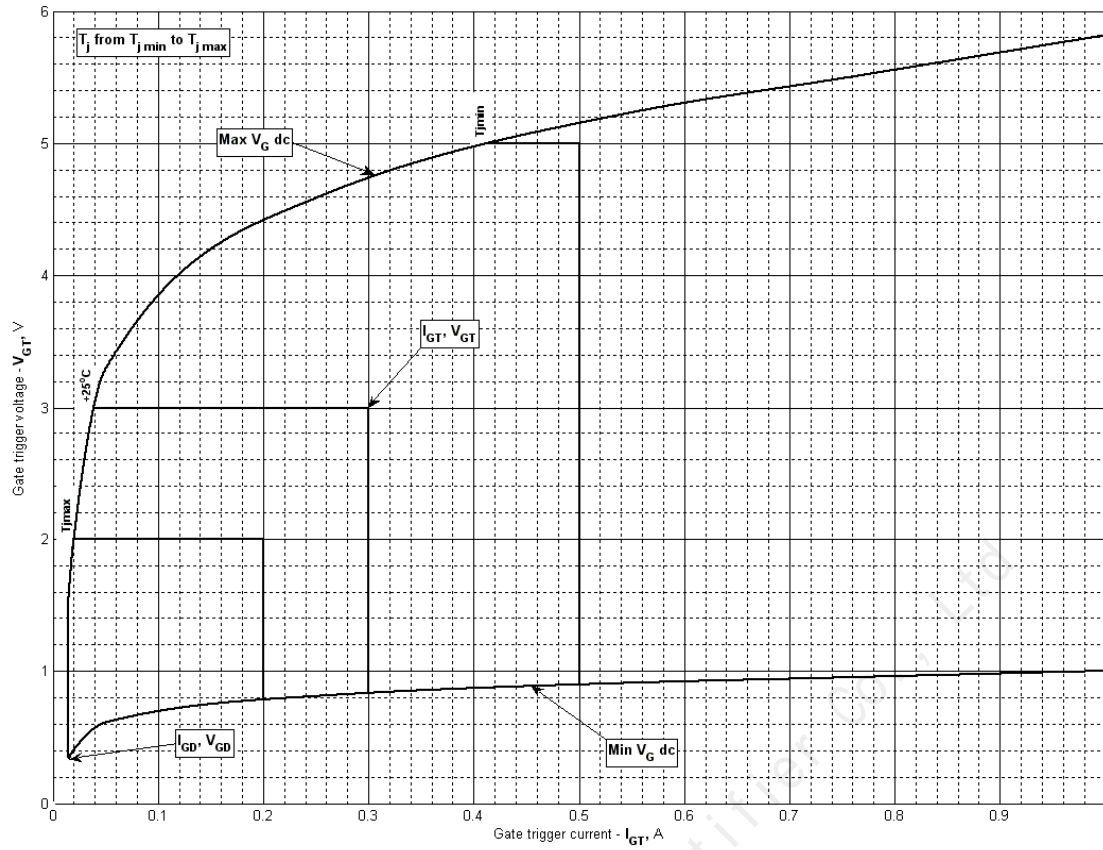

Fig 3 – Gate characteristics – Trigger limits

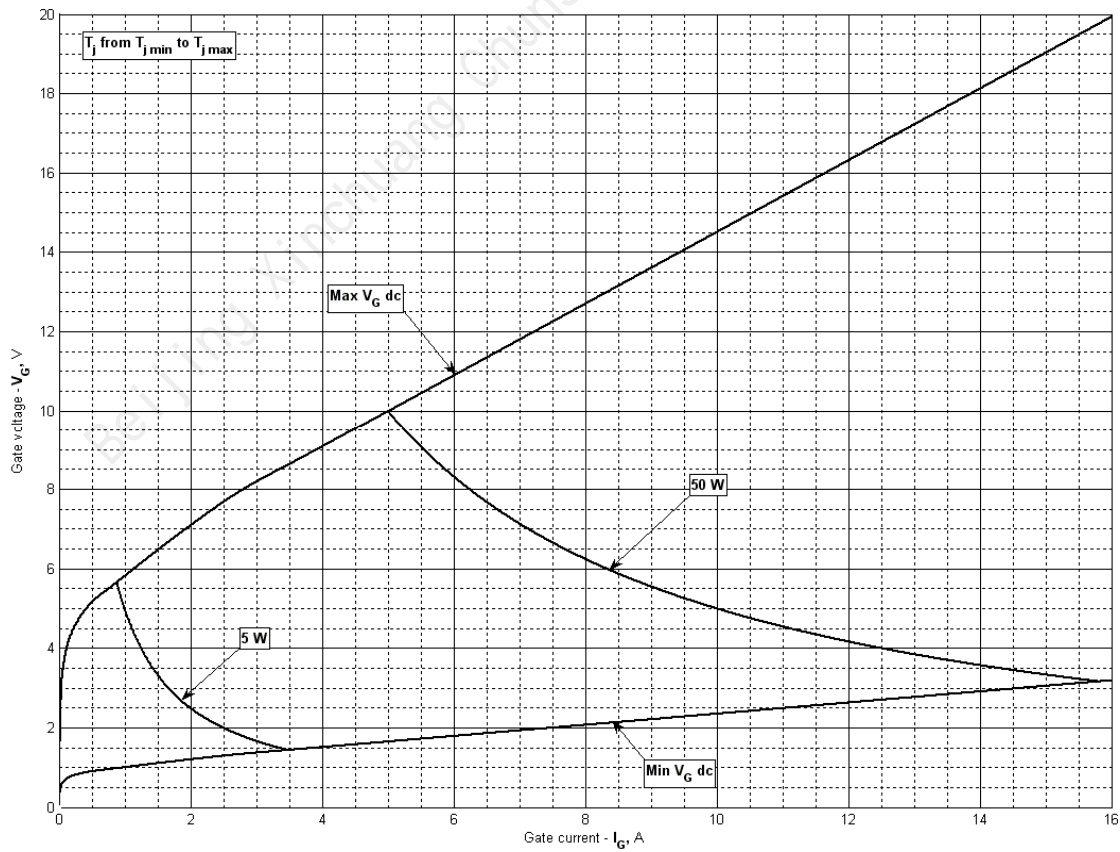

Fig 4 - Gate characteristics –Power curves

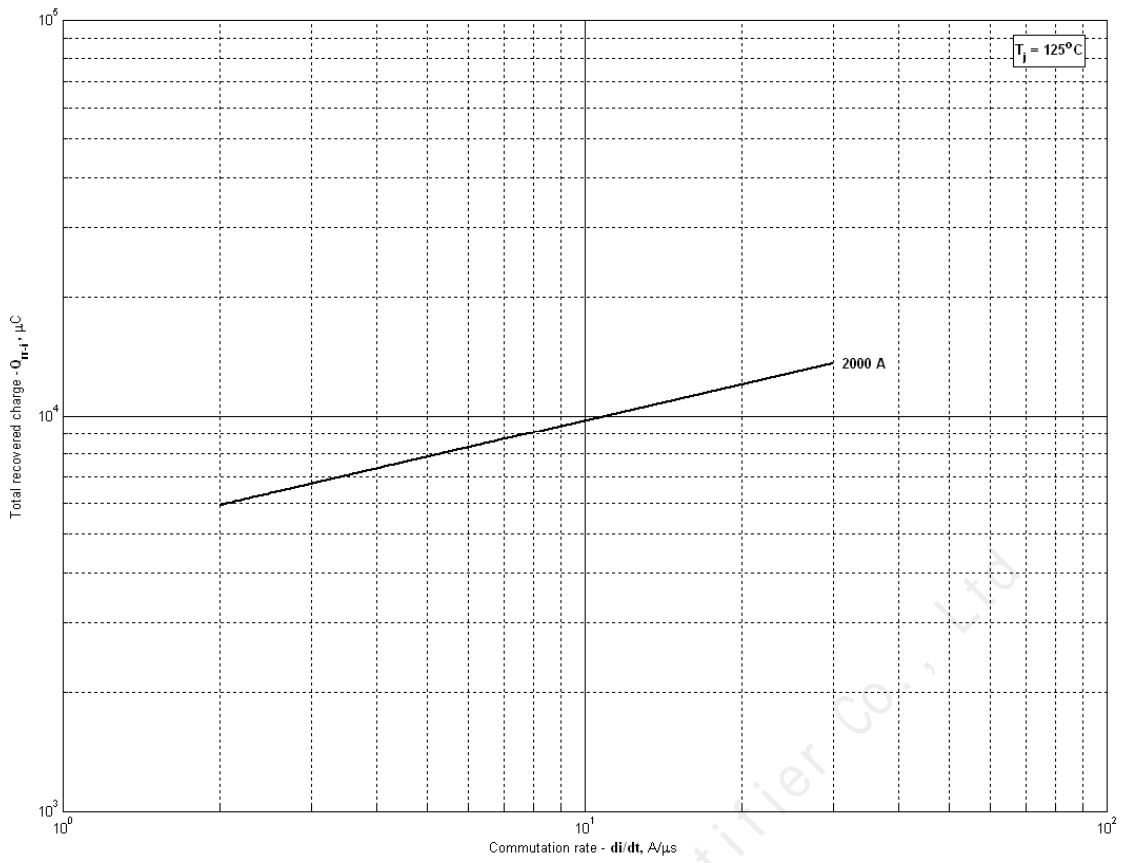

Fig 5 – Total recovered charge, Q_{rr-i} (integral)

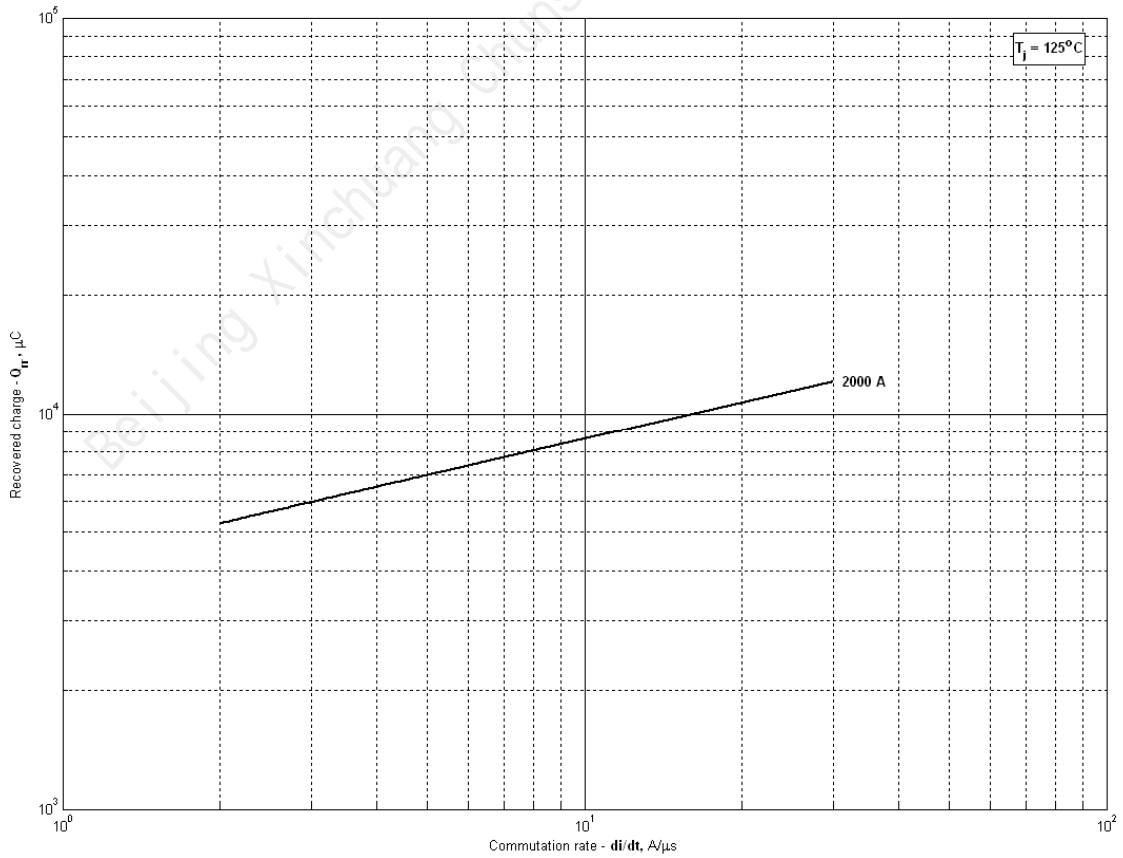

Fig 6 - Recovered charge, Q_{rr} (linear)

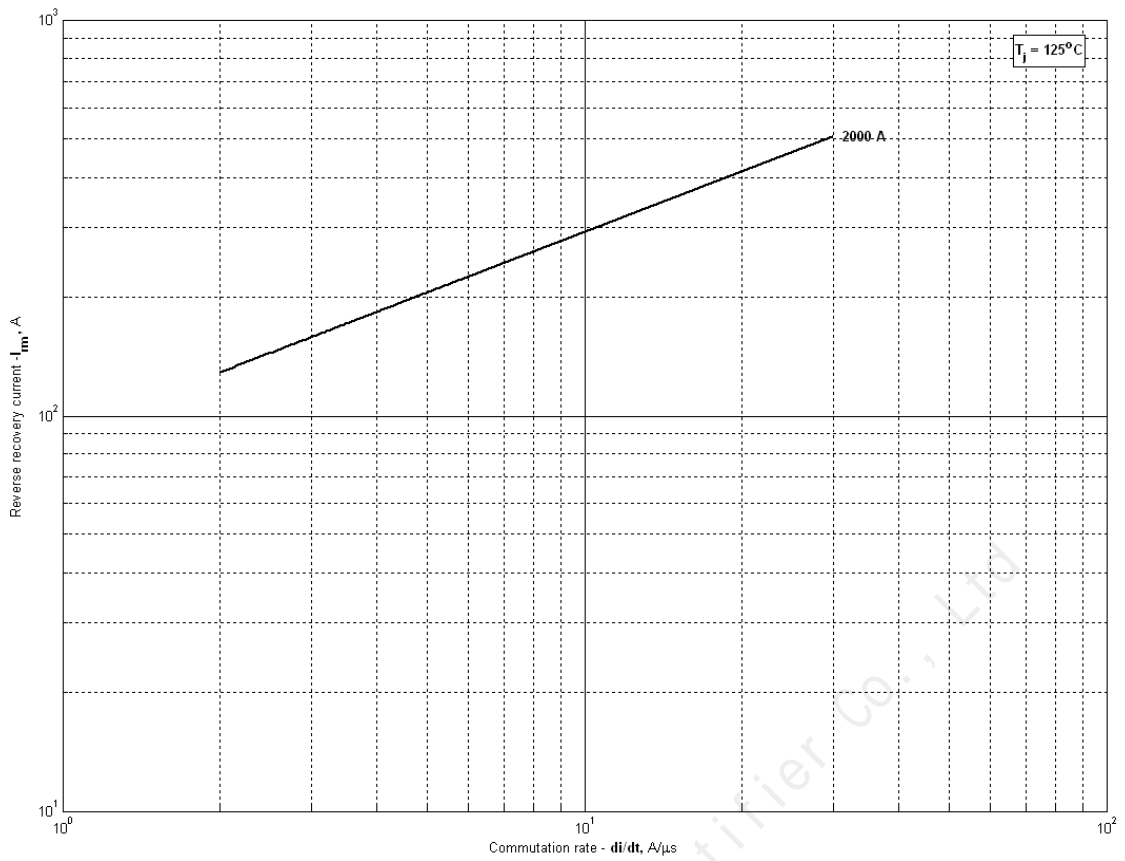

Fig 7 – Peak reverse recovery current, I_{rm}

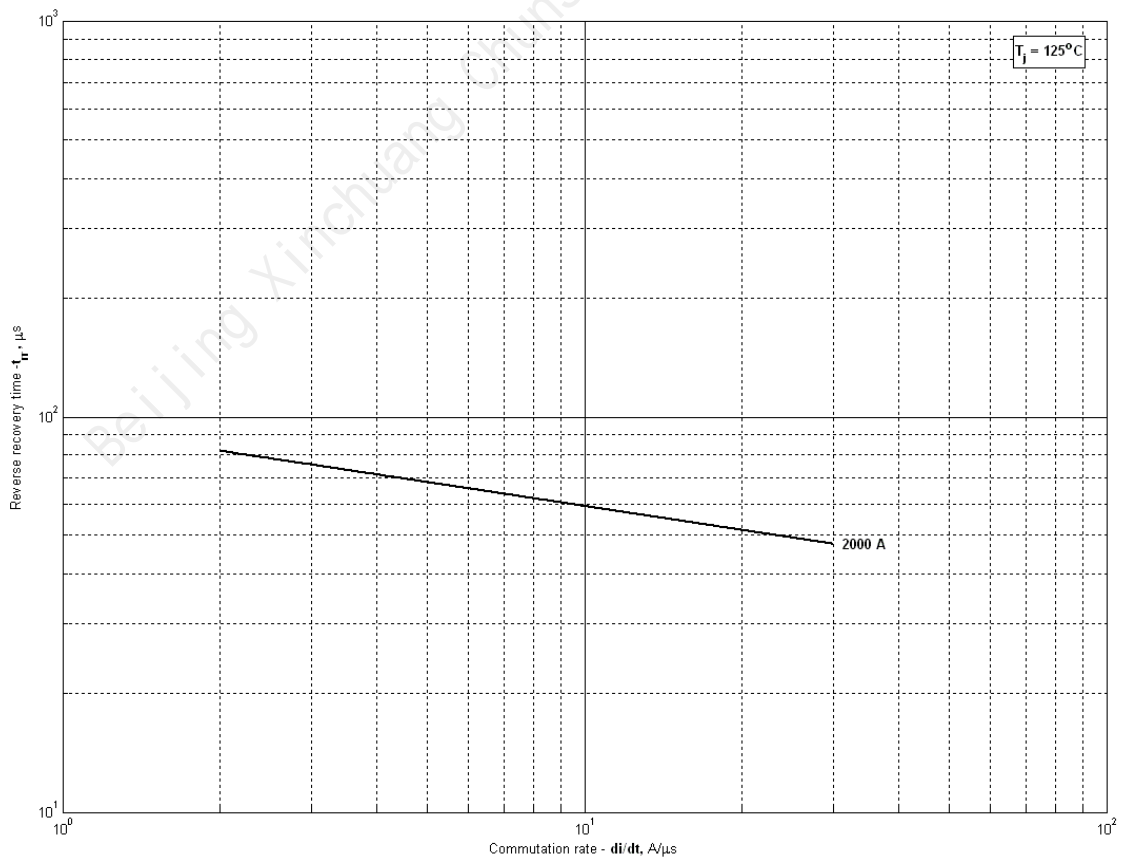

Fig 8 – Maximum recovery time, t_{rr} (linear)

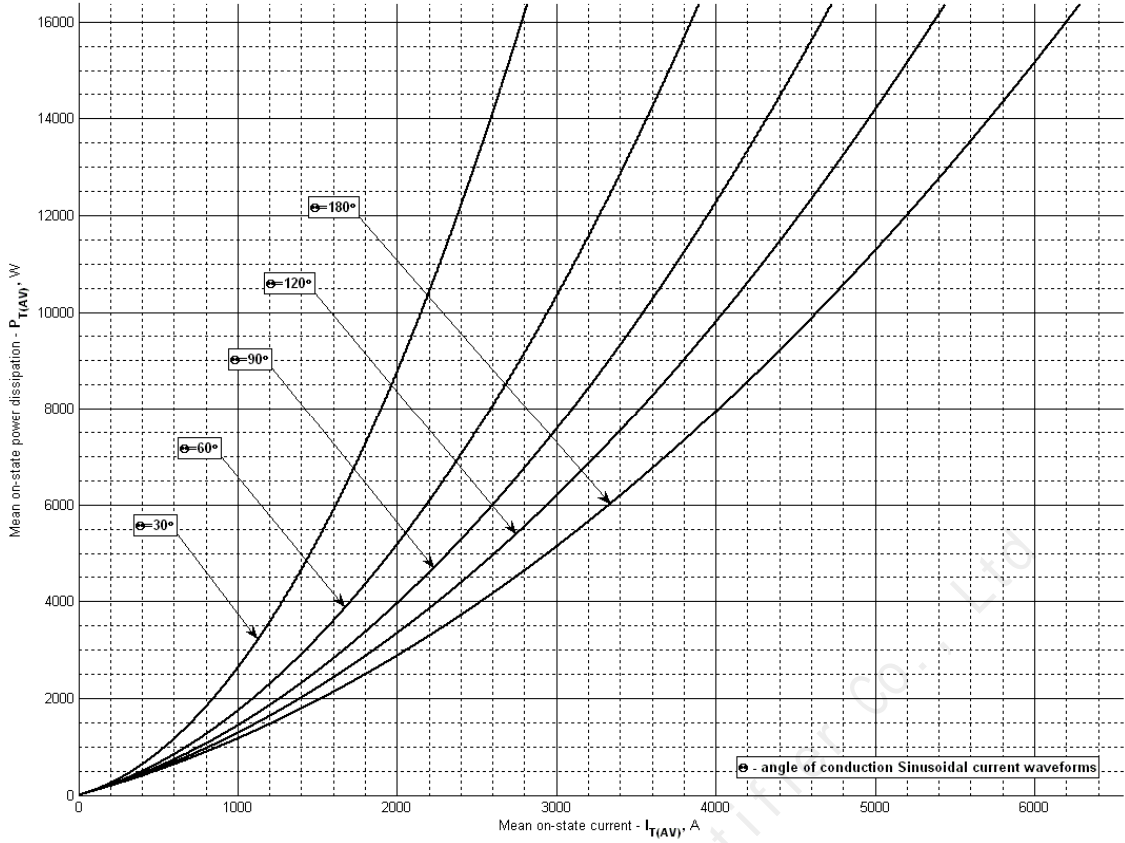

Fig 9 – On-state power loss (sinusoidal current waveforms)

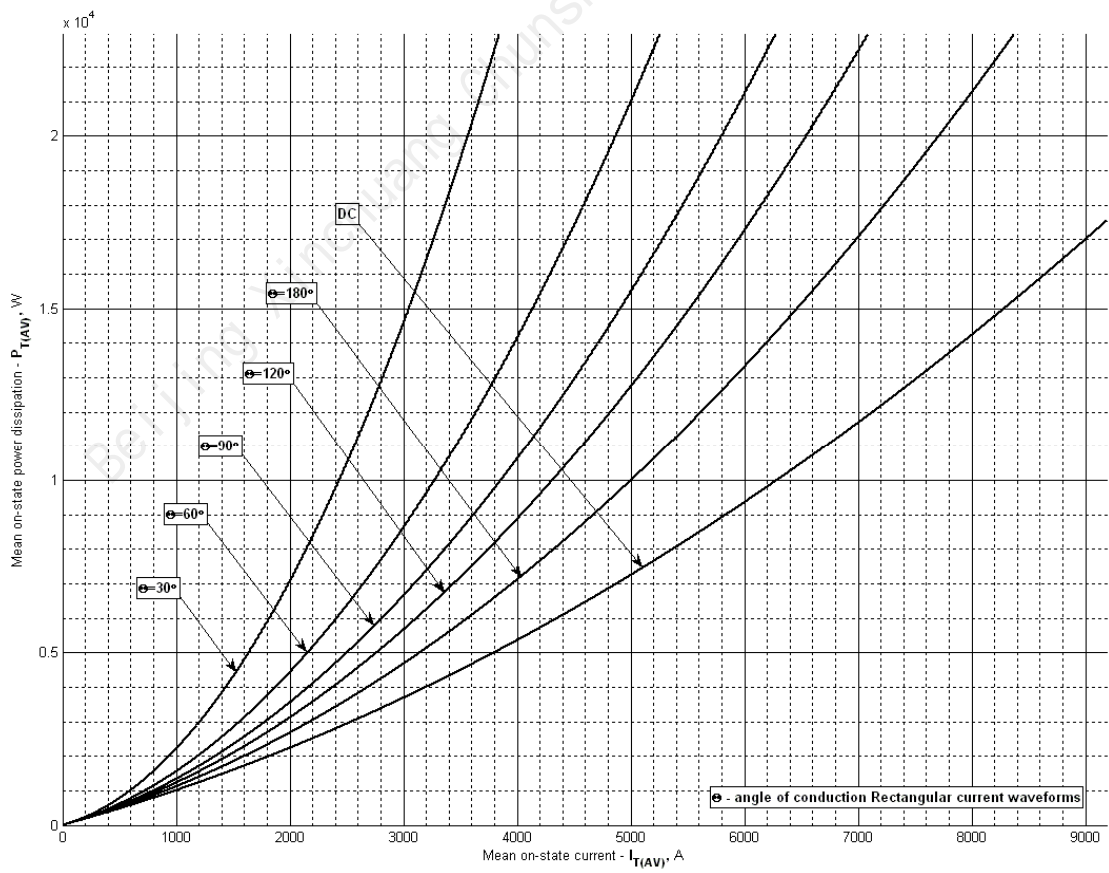

Fig 10 – On-state power loss (rectangular current waveforms)

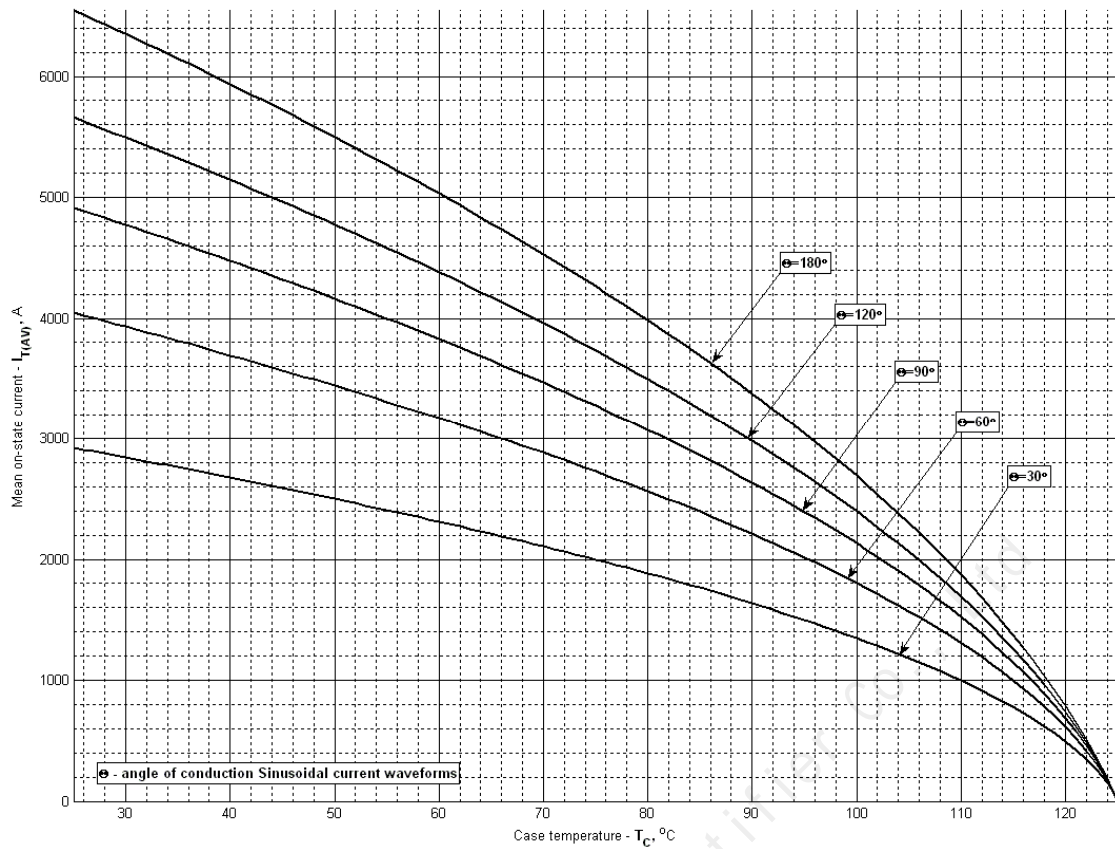

Fig 11 – Maximum case temperature DSC (sinusoidal current waveforms)

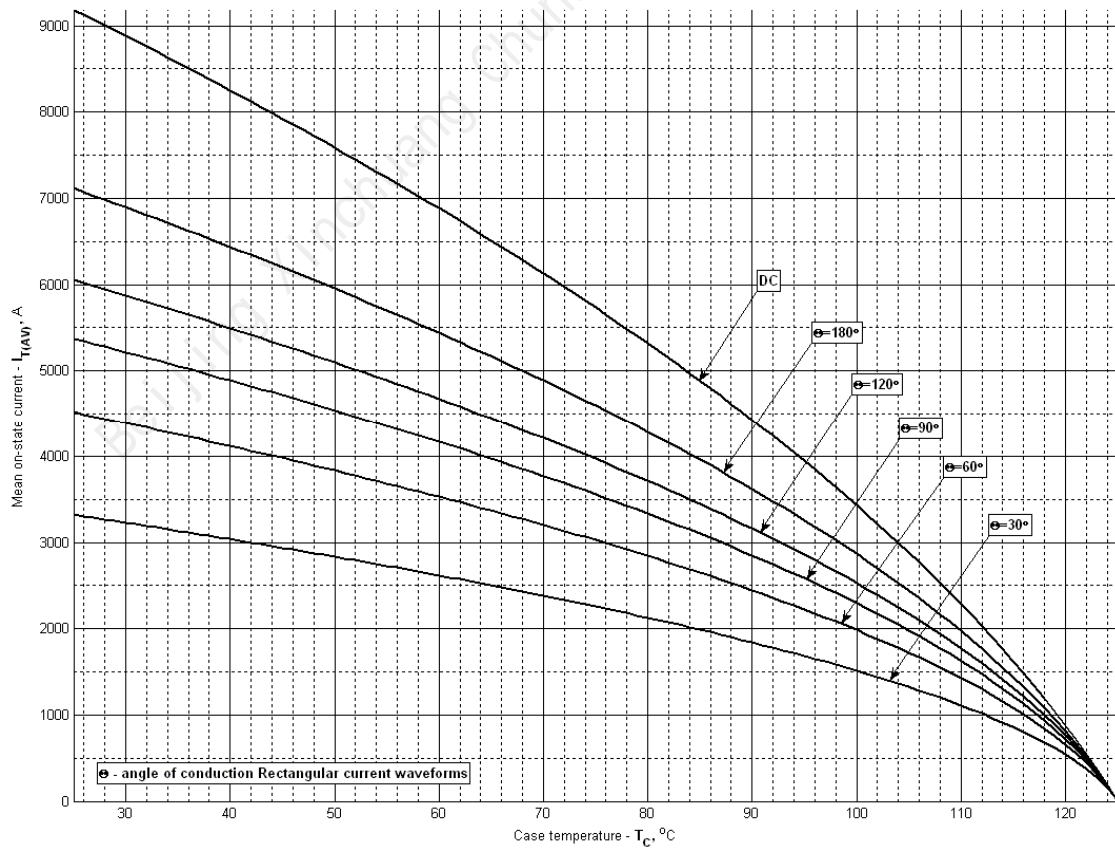

Fig 12 – Maximum case temperature DSC (rectangular current waveforms)

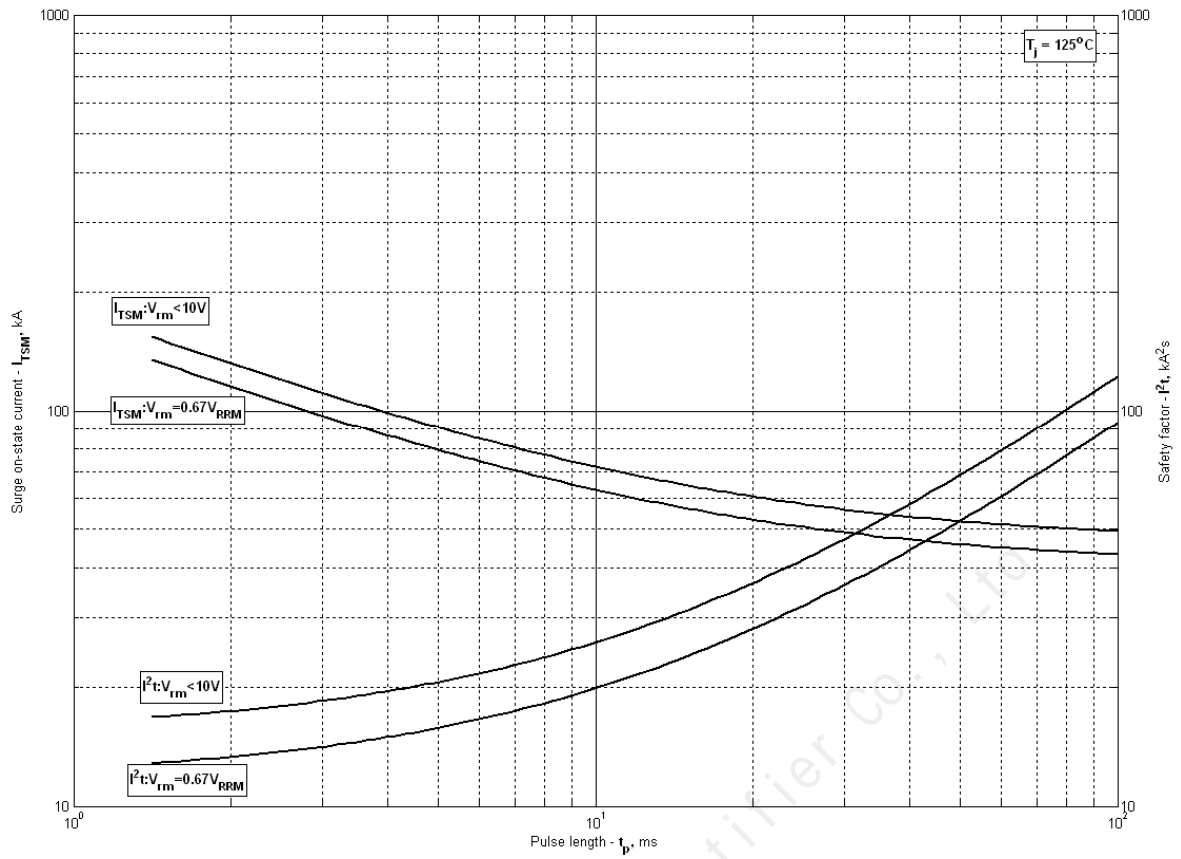

Fig 13 – Maximum surge and I^2t ratings

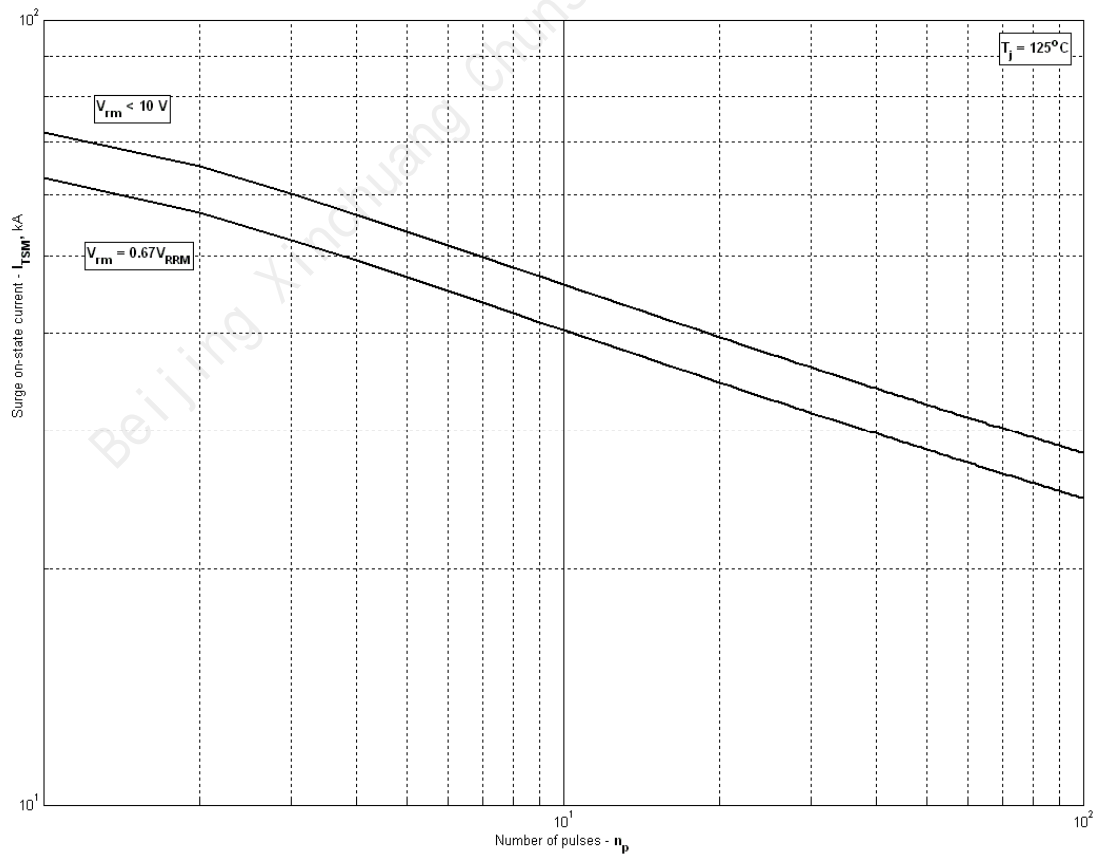

Fig 14 – Maximum surge ratings