



High-end Power Semiconductor Manufacturer

# KP3600A 4600V-5200V Phase Control Thyristor

- High power cycling capability
- Low on-state and switching losses
- Designed for traction and industrial applications



Mean on-state current	$I_{TAV}$	3600 A		
Repetitive peak off-state voltage	$V_{DRM}$	4600 – 5200 V		
Repetitive peak reverse voltage	$V_{RRM}$			
Turn-off time	$t_q$	700 $\mu$ s		
$V_{DRM}, V_{RRM}, V$	4600	4800	5000	5200
Voltage code	46	48	50	52
$T_j, ^\circ C$	– 60 – 125			

## MAXIMUM ALLOWABLE RATINGS

Symbols and parameters		Units	Values	Test conditions
<b>ON-STATE</b>				
$I_{TAV}$	Mean on-state current	A	3600	$T_c = 70^\circ C$ , Double side cooled 180° half-sine wave; 50 Hz
$I_{TRMS}$	RMS on-state current	A	5652	$T_c = 70^\circ C$ , Double side cooled 180° half-sine wave; 50 Hz
$I_{TSM}$	Surge on-state current	kA	50.0 58.0	$T_j = T_{jmax}$ $T_j = 25^\circ C$ 180° half-sine wave; 50 Hz ( $t_p = 10$ ms); single pulse; $V_D = V_R = 0$ V; Gate pulse: $I_G = 2$ A; $t_{GP} = 50 \mu s$ ; $di_G/dt \geq 1$ A/ $\mu s$
			55.0 63.0	$T_j = T_{jmax}$ $T_j = 25^\circ C$ 180° half-sine wave; 60 Hz ( $t_p = 8.3$ ms); single pulse; $V_D = V_R = 0$ V; Gate pulse: $I_G = 2$ A; $t_{GP} = 50 \mu s$ ; $di_G/dt \geq 1$ A/ $\mu s$
$I^2t$	Safety factor	$A^2s \cdot 10^3$	12500 14845	$T_j = T_{jmax}$ $T_j = 25^\circ C$ 180° half-sine wave; 50 Hz ( $t_p = 10$ ms); single pulse; $V_D = V_R = 0$ V; Gate pulse: $I_G = 2$ A; $t_{GP} = 50 \mu s$ ; $di_G/dt \geq 1$ A/ $\mu s$
			13960 18625	$T_j = T_{jmax}$ $T_j = 25^\circ C$ 180° half-sine wave; 60 Hz ( $t_p = 8.3$ ms); single pulse; $V_D = V_R = 0$ V; Gate pulse: $I_G = 2$ A; $t_{GP} = 50 \mu s$ ; $di_G/dt \geq 1$ A/ $\mu s$
<b>BLOCKING</b>				
$V_{DRM}, V_{RRM}$	Repetitive peak off-state and Repetitive peak reverse voltages	V	4600–5200	$T_{jmin} < T_j < T_{jmax}$ ; 180° half-sine wave; 50 Hz; Gate open
$V_{DSM}, V_{RSM}$	Non-repetitive peak off-state and Non-repetitive peak reverse voltages	V	4700–5300	$T_{jmin} < T_j < T_{jmax}$ ; 180° half-sine wave; 50 Hz; single pulse; Gate open
$V_D, V_R$	Direct off-state and Direct reverse voltages	V	$0.75 \cdot V_{DRM}$ $0.75 \cdot V_{RRM}$	$T_j = T_{jmax}$ ; Gate open

<b>TRIGGERING</b>				
$I_{FGM}$	Peak forward gate current	A	12	$T_j = T_{j\max}$
$V_{RGM}$	Peak reverse gate voltage	V	5	
$P_G$	Gate power dissipation	W	5	$T_j = T_{j\max}$ for DC gate current
<b>SWITCHING</b>				
$(di_T/dt)_{crit}$	Critical rate of rise of on-state current non-repetitive (f=1 Hz)	A/ $\mu$ s	1000	$T_j = T_{j\max}$ ; $V_D = 0.67 \cdot V_{DRM}$ ; $I_{TM} = 2 I_{TAV}$ ; Gate pulse: $I_G = 2$ A; $t_{GP} = 50 \mu$ s; $di_G/dt \geq 1$ A/ $\mu$ s
<b>THERMAL</b>				
$T_{stg}$	Storage temperature	$^{\circ}$ C	-60 - 125	
$T_j$	Operating junction temperature	$^{\circ}$ C	-60 - 125	
<b>MECHANICAL</b>				
F	Mounting force	kN	70.0 - 90.0	
a	Acceleration	m/s <sup>2</sup>	50 100	Device unclamped Device clamped

## CHARACTERISTICS

Symbols and parameters		Units	Values	Conditions	
<b>ON-STATE</b>					
$V_{TM}$	Peak on-state voltage, max	V	1.48	$T_j = 25 \text{ }^{\circ}$ C; $I_{TM} = 3000$ A	
$V_{T(TO)}$	On-state threshold voltage, max	V	1.10	$T_j = T_{j\max}$ ;	
$r_T$	On-state slope resistance, max	m $\Omega$	0.15	$0.5 \pi I_{TAV} < I_T < 1.5 \pi I_{TAV}$	
$I_L$	Latching current, max	mA	1000	$T_j = 25 \text{ }^{\circ}$ C; $V_D = 12$ V; Gate pulse: $I_G = 2$ A; $t_{GP} = 50 \mu$ s; $di_G/dt \geq 1$ A/ $\mu$ s	
$I_H$	Holding current, max	mA	200	$T_j = 25 \text{ }^{\circ}$ C; $V_D = 12$ V; Gate open	
<b>BLOCKING</b>					
$I_{DRM}, I_{RRM}$	Repetitive peak off-state and Repetitive peak reverse currents, max	mA	300	$T_j = T_{j\max}$ ; $V_D = V_{DRM}$ ; $V_R = V_{RRM}$	
$(dv_D/dt)_{crit}$	Critical rate of rise of off-state voltage <sup>1)</sup> , min	V/ $\mu$ s	1000	$T_j = T_{j\max}$ ; $V_D = 0.67 \cdot V_{DRM}$ ; Gate open	
<b>TRIGGERING</b>					
$V_{GT}$	Gate trigger direct voltage, max	V	2.50 2.00	$T_j = 25 \text{ }^{\circ}$ C $T_j = T_{j\max}$	$V_D = 12$ V; $I_D = 3$ A; Direct gate current
$I_{GT}$	Gate trigger direct current, max	mA	200 90	$T_j = 25 \text{ }^{\circ}$ C $T_j = T_{j\max}$	
$V_{GD}$	Gate non-trigger direct voltage, min	V	0.35	$T_j = T_{j\max}$ ; $V_D = 0.67 \cdot V_{DRM}$ ;	
$I_{GD}$	Gate non-trigger direct current, min	mA	15.00	Direct gate current	
<b>SWITCHING</b>					
$t_{gd}$	Delay time	$\mu$ s	3.00	$T_j = 25 \text{ }^{\circ}$ C; $V_D = 0.4 \cdot V_{DRM}$ ; $I_{TM} = 1000$ A; Gate pulse: $I_G = 2$ A; $t_{GP} = 50 \mu$ s; $di_G/dt \geq 1$ A/ $\mu$ s	
$t_q$	Turn-off time <sup>2)</sup> , max	$\mu$ s	700	$dv_D/dt = 30$ V/ $\mu$ s; $T_j = T_{j\max}$ ; $I_{TM} = 2000$ A; $di_R/dt = -10$ A/ $\mu$ s; $V_R = 100$ V; $V_D = 0.67 V_{DRM}$ ;	
$Q_{rr}$	Total recovered charge, max	$\mu$ C	5000	$T_j = T_{j\max}$ ; $I_{TM} = 2000$ A;	
$t_{rr}$	Reverse recovery time, typ	$\mu$ s	95	$di_R/dt = -5$ A/ $\mu$ s;	
$I_{rrM}$	Peak reverse recovery current, max	A	210	$V_R = 100$ V	

<b>THERMAL</b>					
$R_{thjc}$	Thermal resistance, junction to case, max	°C/W	0.0060	Direct current	Double side cooled
$R_{thjc-A}$			0.0110		Anode side cooled
$R_{thjc-K}$			0.0090		Cathode side cooled
$R_{thck}$	Thermal resistance, case to heatsink, max	°C/W	0.0015	Direct current	
<b>MECHANICAL</b>					
w	Weight, typ	g	2200		
$D_s$	Surface creepage distance	mm (inch)	44.60 (1.756)		
$D_a$	Air strike distance	mm (inch)	15.70 (0.618)		

Beijing Xinchuang Chunshu Rectifier Co., Ltd

**OVERALL DIMENSIONS**

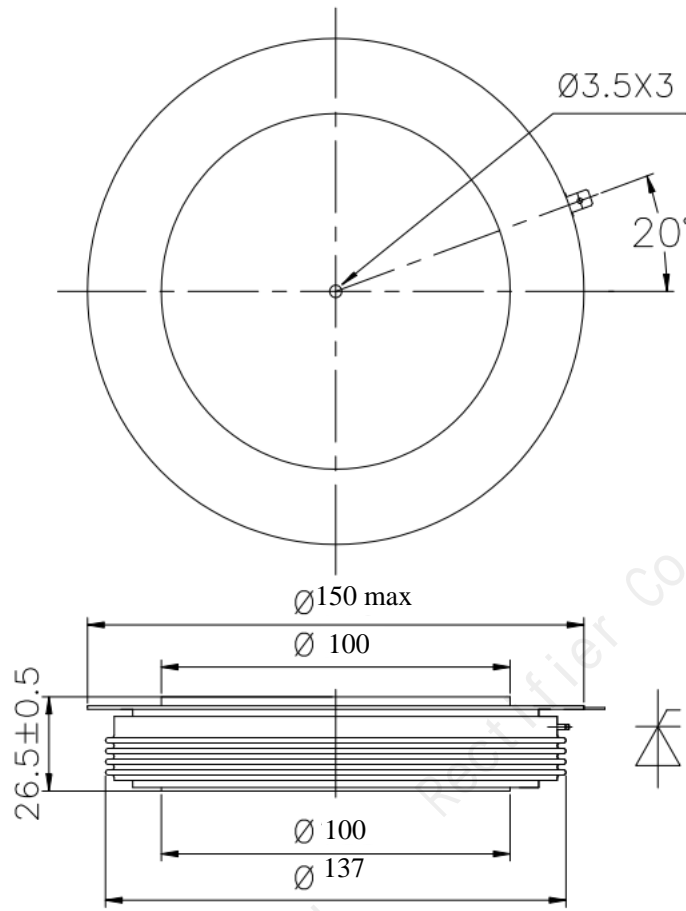

KT110

All dimensions in millimeters

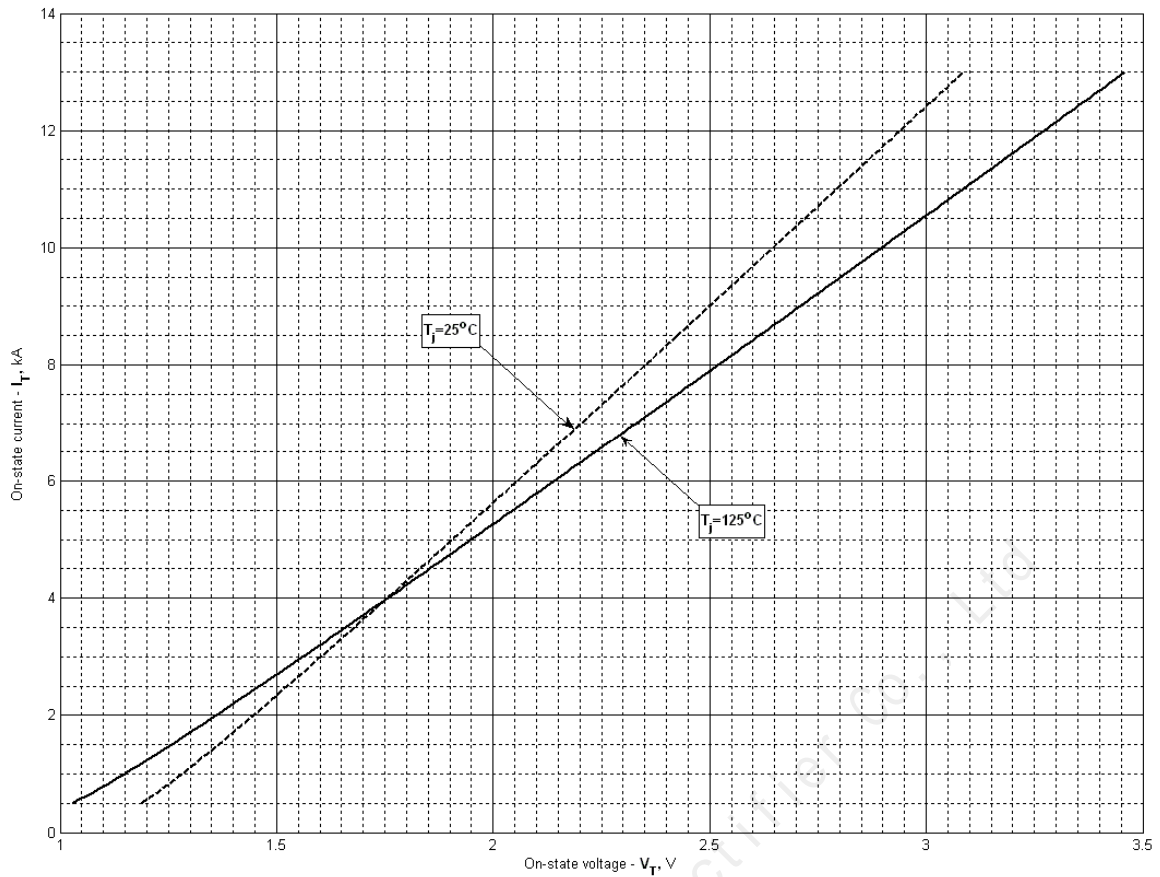

**Fig 1 – On-state characteristics of Limit device**

Analytical function for On-state characteristic:

$$V_T = A + B \cdot i_T + C \cdot \ln(i_T + 1) + D \cdot \sqrt{i_T}$$

	Coefficients for max curves	
	$T_j = 25^\circ\text{C}$	$T_j = T_{j\max}$
<b>A</b>	1.131336	0.956898
<b>B</b>	0.148813	0.190428
<b>C</b>	0.119148	0.159131
<b>D</b>	-0.081896	-0.109378

**On-state characteristic model (see Fig. 1)**

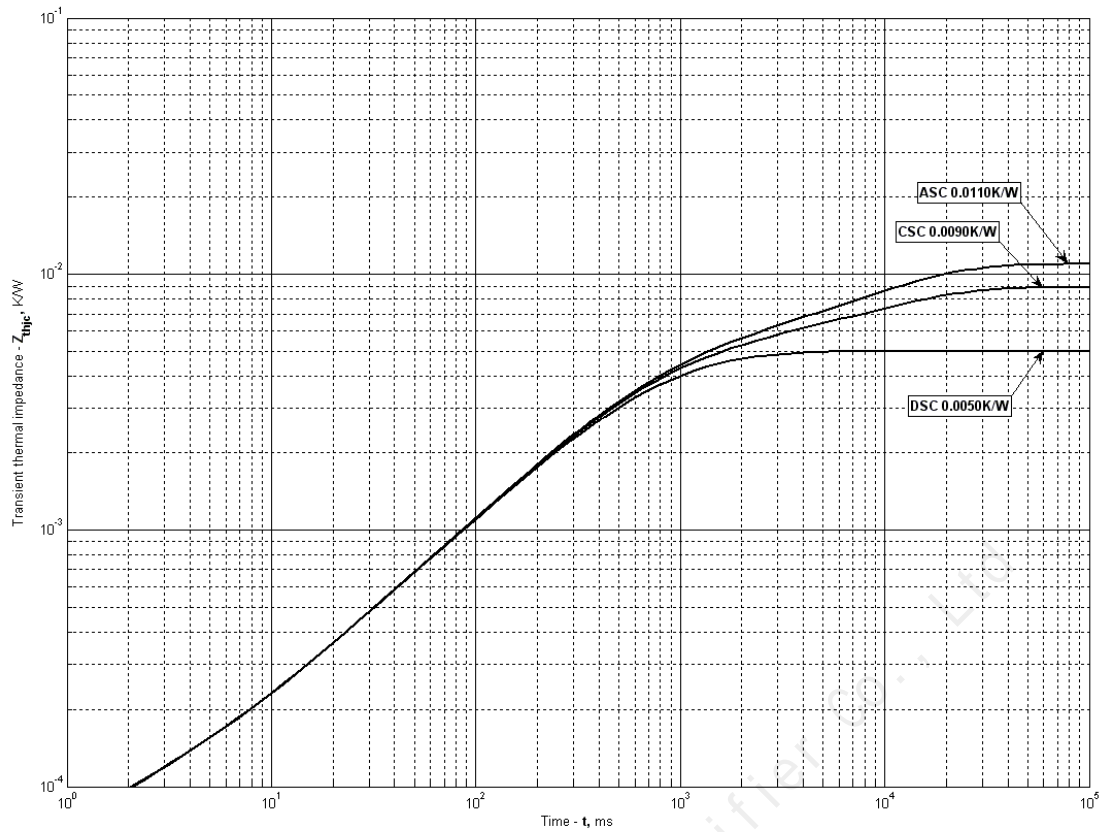

**Fig 2 – Transient thermal impedance**

Analytical function for Transient thermal impedance junction to case  $Z_{thjc}$  for DC:

$$Z_{thjc} = \sum_{i=1}^n R_i \left( 1 - e^{-\frac{t}{\tau_i}} \right)$$

Where  $i = 1$  to  $n$ ,  $n$  is the number of terms in the series.

$t$  = Duration of heating pulse in seconds.

$Z_{thjc}$  = Thermal resistance at time  $t$ .

$R_i$  = Amplitude of  $p_{th}$  term.

$\tau_i$  = Time constant of  $r_{th}$  term.

DC Double side cooled

$i$	1	2	3	4	5	6
$R_{ij}$ K/W	0.002027	0.0001166	0.002627	0.0001539	3.237e-005	4.335e-005
$\tau_{ij}$ s	1.059	0.080	0.3836	0.02289	0.0003559	0.001397

DC Cathode side cooled

$i$	1	2	3	4	5	6
$R_{ij}$ K/W	0.003885	0.002188	0.002508	0.0002154	3.854e-005	4.646e-005
$\tau_{ij}$ s	10.6	1.090	0.3745	0.03207	0.002565	0.0004383

DC Anode side cooled

$i$	1	2	3	4	5	6
$R_{ij}$ K/W	0.005945	0.002218	0.00248	0.0002153	3.862e-005	4.604e-005
$\tau_{ij}$ s	10.6	1.120	0.3786	0.03196	0.002513	0.0004352

**Transient thermal impedance junction to case  $Z_{thjc}$  model (see Fig. 2)**

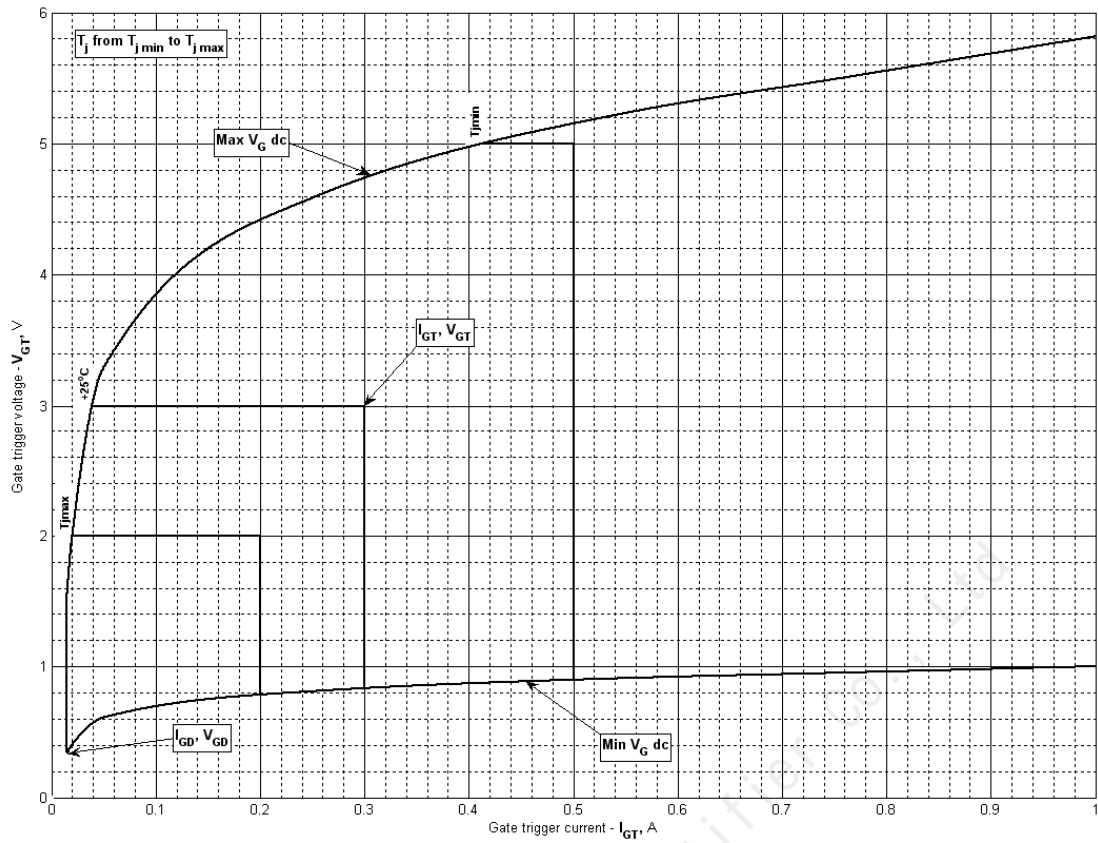

**Fig 3 – Gate characteristics – Trigger limits**

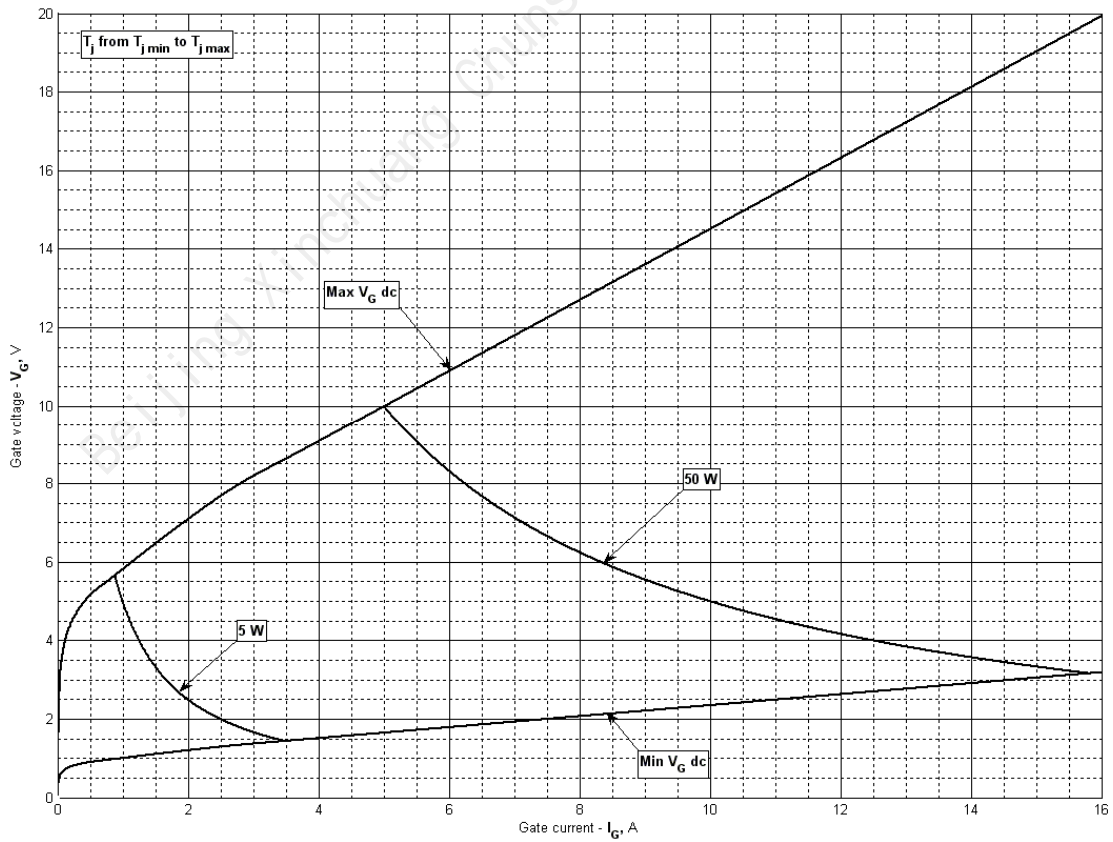

**Fig 4 - Gate characteristics –Power curves**

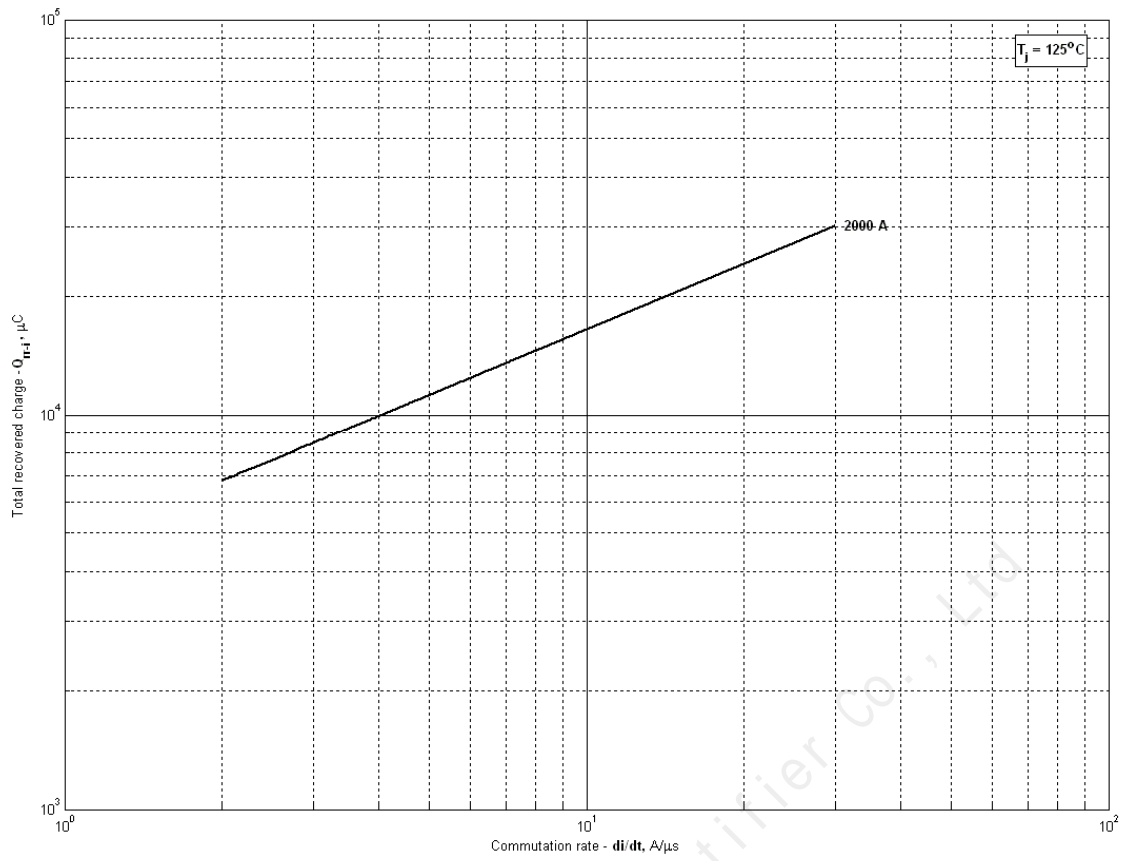
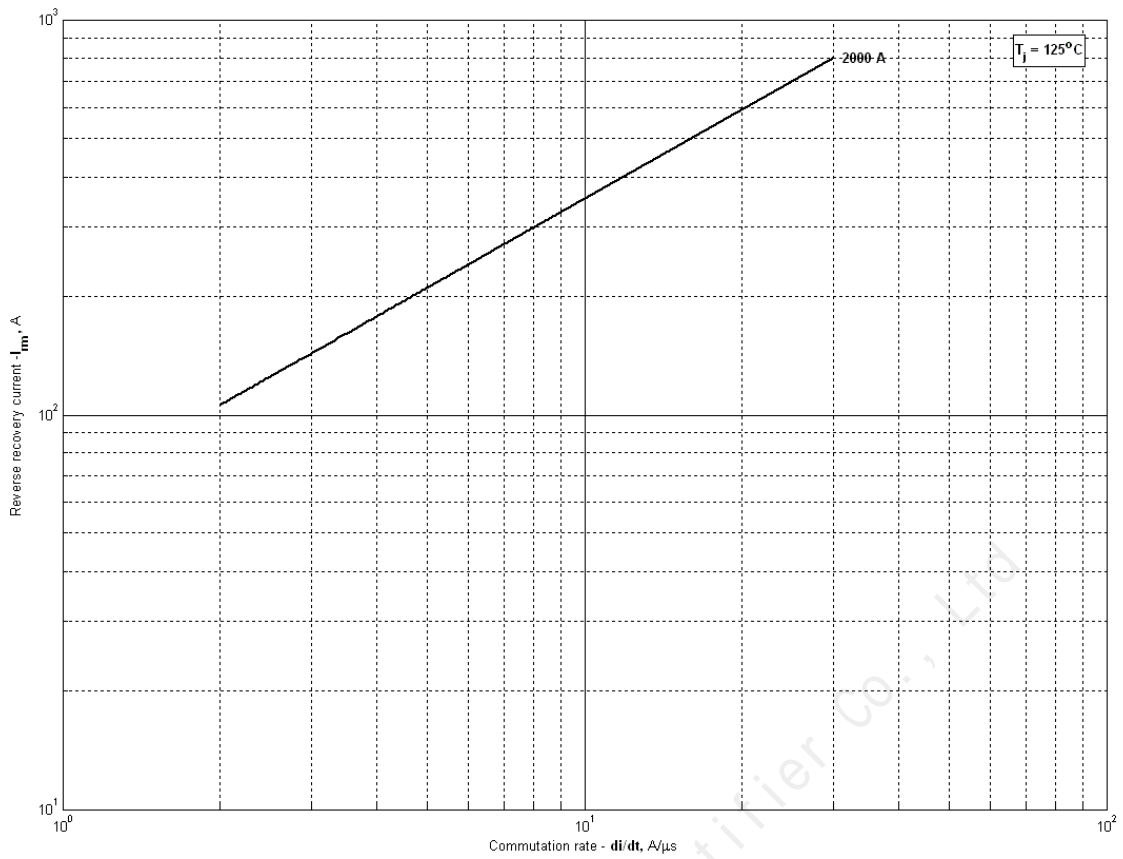

**Fig 5 – Total recovered charge,  $Q_{rr-i}$  (integral)**

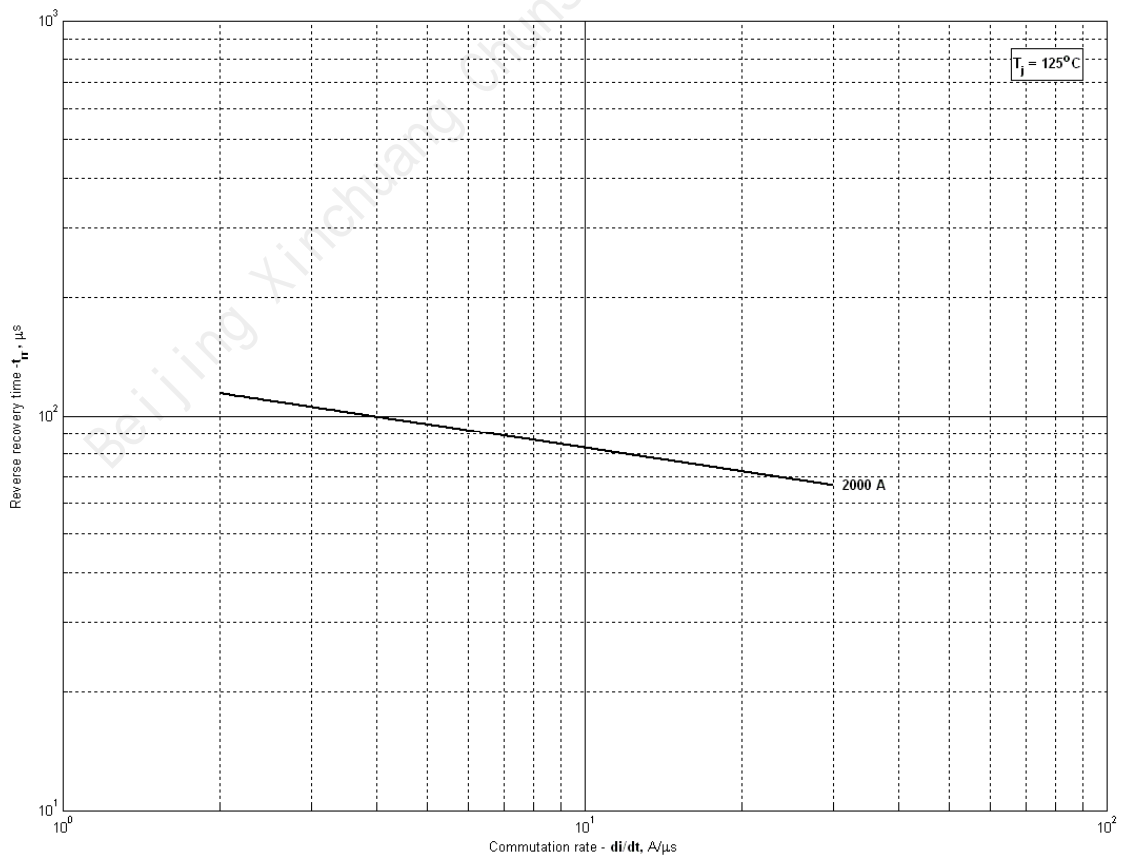

**Fig 6 - Recovered charge,  $Q_{rr}$  (linear)**

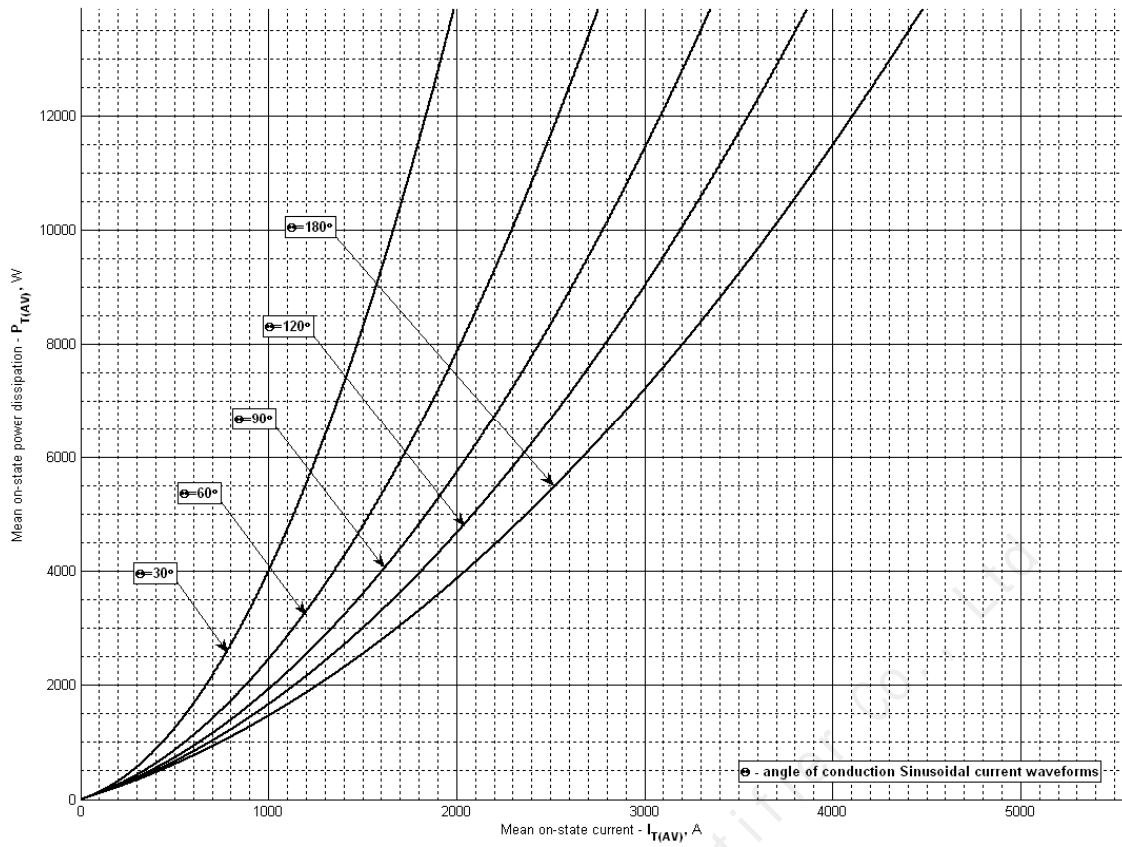



**Fig 7 – Peak reverse recovery current,  $I_{rm}$**



**Fig 8 – Maximum recovery time,  $t_{rr}$  (linear)**



**Fig 9 – On-state power loss (sinusoidal current waveforms)**

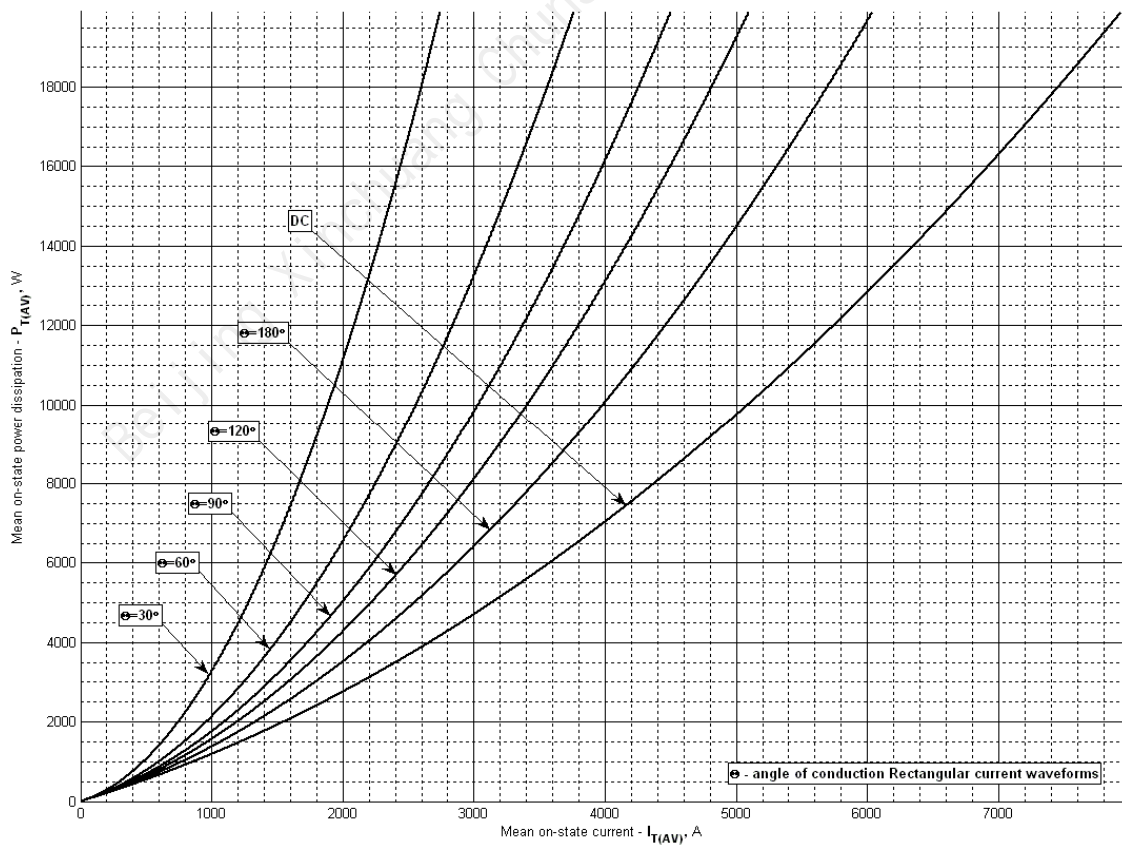

**Fig 10 – On-state power loss (rectangular current waveforms)**

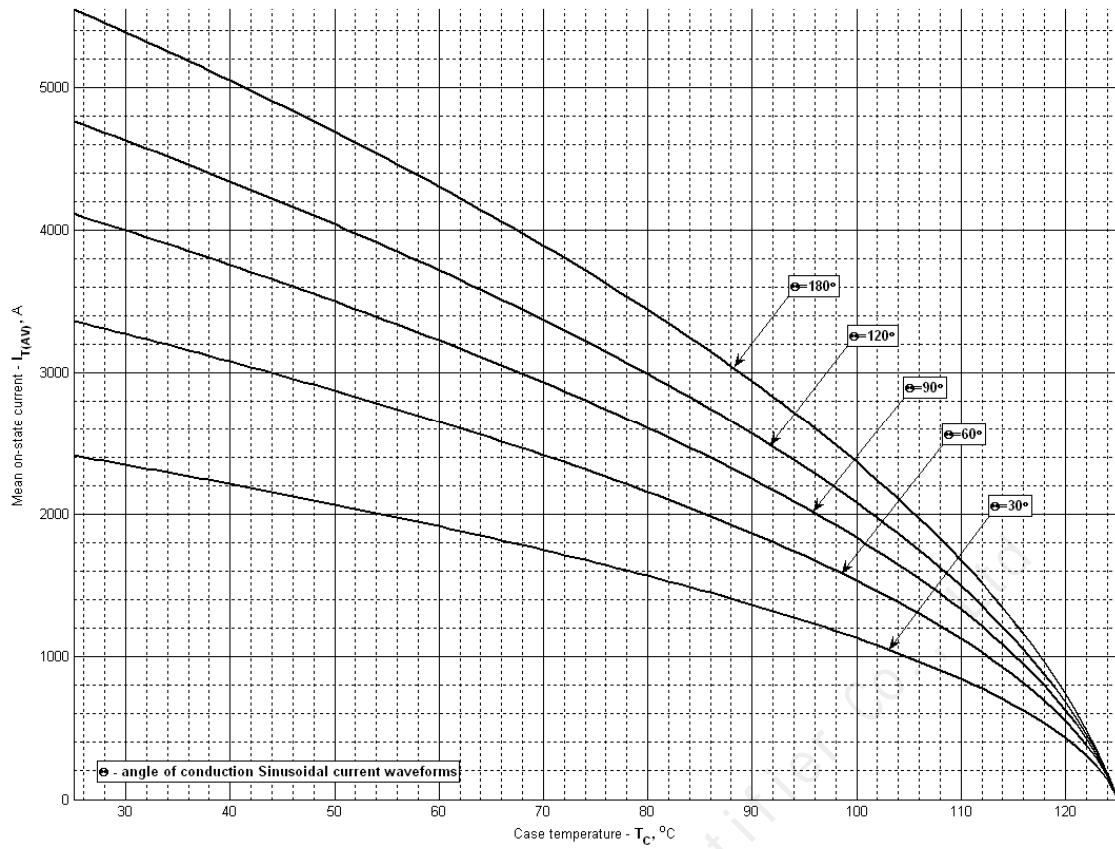

**Fig 11 – Maximum case temperature DSC (sinusoidal current waveforms)**

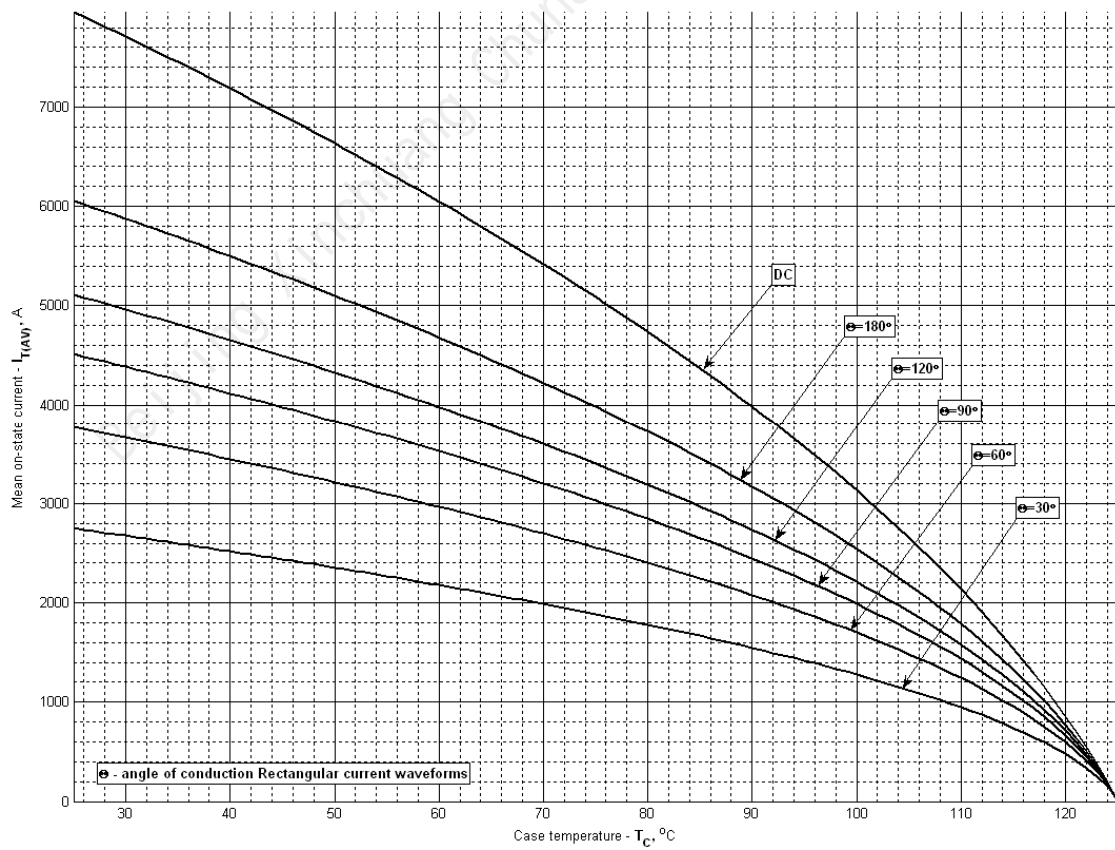

**Fig 12 – Maximum case temperature DSC (rectangular current waveforms)**

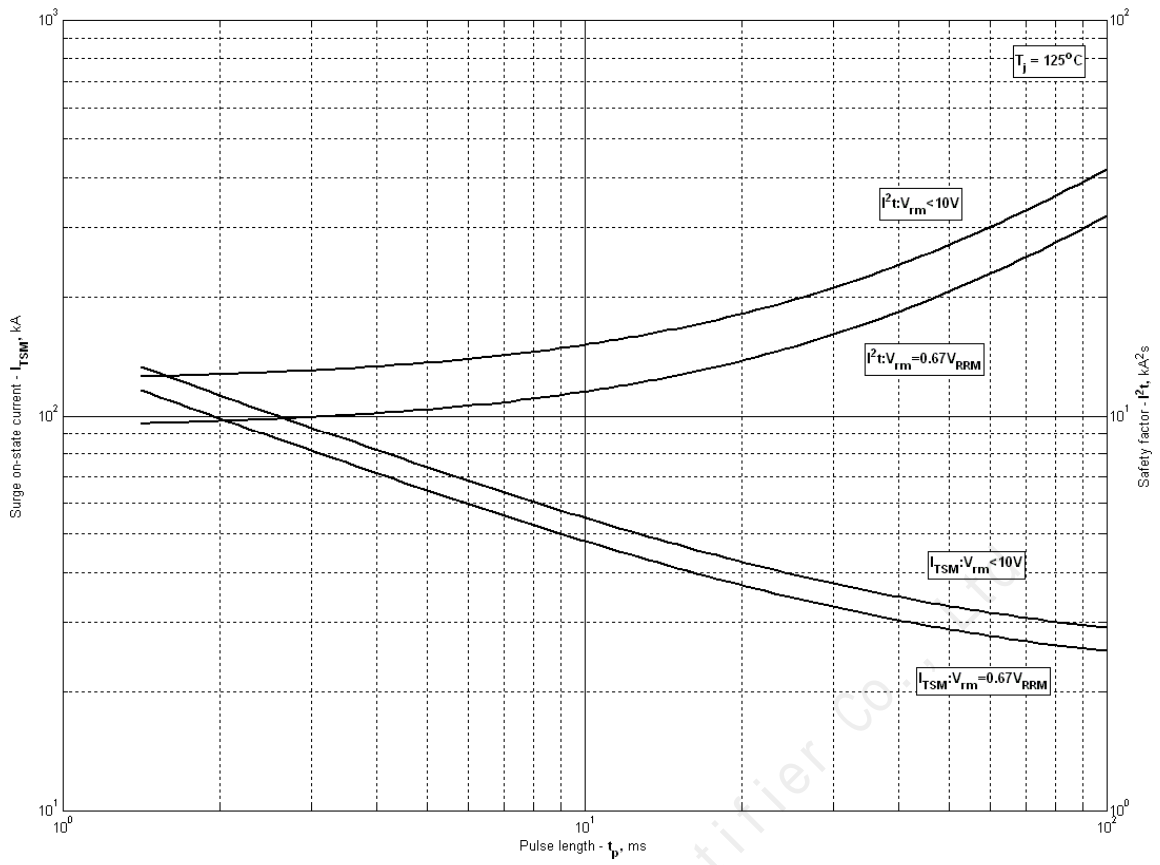

**Fig 13 – Maximum surge and  $I^2t$  ratings**

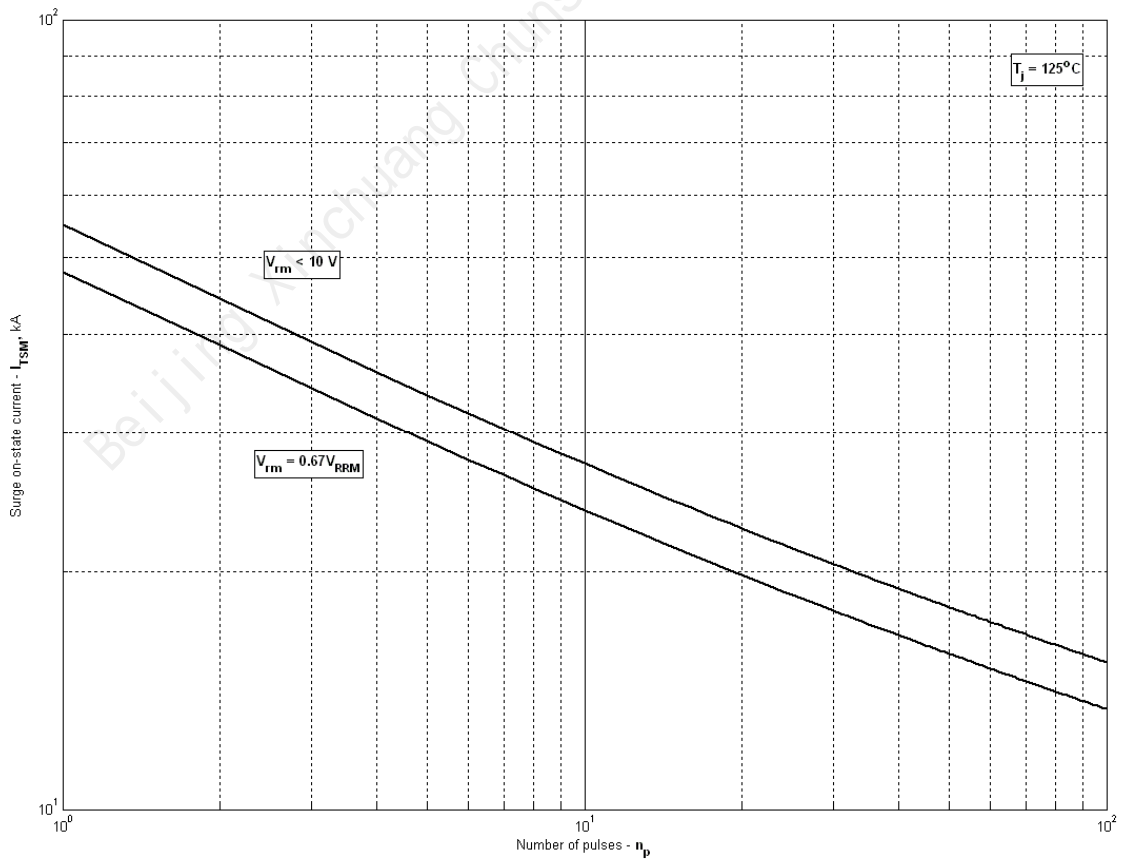

**Fig 14 – Maximum surge ratings**